

- Informazioni
Information
Informations
Información
- 3 Caratteristiche tecniche
5 Technical details
7 Caractéristiques techniques
9 Características técnicas
- 11 Peso, volume, colli
Weight, volumes, packages
Poids, volume, colis
Peso, volumen, bultos
- 12 Abbinamenti colore e come ordinare
Colour matching and how to order
Association coloris et comment passer la commande
Combinación de colores y modo de hacer pedidos
- 17 Esplicativo componibilità
Composition details
Détails de composition
Explicativo de la composición
- Scrivanie
Desks
Bureaux
Escritorios
- 18 Scrivanie
Desks
Bureaux
Escritorios
- 23 Complanari
Return tops
Retours
Extensiones
- 27 Elementi aggiuntivi per complanari
Additional components for return tops
Éléments additionnels pour retours
Componentes añadidos para extensiones
- 29 Zona di attesa
Waiting area
Zone d'accueil
Zona de espera
- 30 Tavoli riunione
Meeting tables
Tables réunion
Mesas de reuniones
- 32 Elementi aggiuntivi per tavoli riunione
Additional components for meeting tables
Éléments additionnels pour tables réunion
Componentes añadidos para mesas de reuniones
- Cassettiere e serventi
Drawer units and pedestals
Caissons et dessertes
Cajoneras y pedestales
- 34 Cassettiere portanti
Bearing drawer units
Caissons portants
Cajoneras portantes
- 36 Cassettiere su ruote
Drawer units with castors
Caissons sur roulettes
Cajoneras con ruedas
- 37 Accessori per cassettiere
Accessories for drawer units
Accessoires pour caissons
Accesorios para cajoneras
- 39 Boiserie H 201/P 53
Boiseries H 201/P 53
Boiseries H 201/P 53
Boiserie H 201/P 53
- 41 Esplicativo componibilità serventi
Pedestal modularità
Details de composition pour deserte
Explicativo para componentes de pedestales
- 44 Serventi H55 / P60
Pedestals H55 / P60
Dessertes H55 / P60
Pedestales H55 / P60

Caratteristiche fisico-meccaniche dei pannelli in nobilitato melaminico

Emissione di formaldeide: E1.

Spessori: cm 1.2 - 1.8 - 2.8.

Densità: kg 660 (+ -3%) mc (DIN 68763/81).

Piani in nobilitato

Scrivanie/ Complanari/Tavoli riunione

Nobilitato melaminico di qualità E1.

Spessore: cm 2.8 con bordo in ABS 20/10 stondato antiurto su tutti i lati.

Colori: WE Wengé - RC Rovere chiaro

Struttura posti lavoro

Scrivanie/Tavoli riunione

Fianchi realizzati in tamburato spessore cm 7.5 con bordo ABS 20/10 stondato antiurto. Basamento in nobilitato con finitura alluminio spessore cm 1.8 dotato di piedini di livellamento.

Colori: WE Wengé

Pannelli di collegamento fianchi realizzati in nobilitato melaminico di qualità E1 con spessore cm 1.8.

Colori: WE Wengé - RC Rovere chiaro

Staffe di fissaggio piani realizzate in pressofusione di alluminio.

Colori: Z Alluminio goffrato

Elementi aggiuntivi piani

Scrivanie/Complanari/Tavoli riunione

Testate di finitura

Realizzate in estruso di alluminio, complete di tappi di finitura realizzati in pressofusione di zama verniciati a polveri epossidiche.

Colori: Z Alluminio goffrato

Piani in cristallo

Vetro temperato e serigrafato, spessore cm 1, completo di guarnizione in gomma antiscivolo per il fissaggio al piano scrivania sottostante. Nei piani composti da 2 componenti (tavoli riunione) viene inserito un profilo in estruso di alluminio con finitura goffrata, dotato di biadesivo per l'unione dei 2 componenti stessi.

Colori: R Rosso - M Moka - B Beige - W Bianco

Piani in pelle

Realizzati con piano interno in truciolare e rivestimento in pelle, completo di guarnizione in gomma, antiscivolo per il fissaggio al piano scrivania sottostante.

Colori: R Rosso - M Moka - B Beige - W Bianco

Cassettiere portanti

Struttura

Nobilitato melaminico di qualità E1, spessore cm 1.8. Basamento in nobilitato con finitura alluminio spessore cm 1.8 dotato di piedini di livellamento.

Complete di serratura con chiusura simultanea dei cassetti. Maniglia in zama con finitura nichel satinato.

Colori: WE Wengé

Parti frontali

Nobilitato melaminico di qualità E1. Spessore cm 1.8 con bordo ABS 15/10 stondato antiurto nelle parti verticali e altri bordi in ABS 6/10.

Colori: WE Wengé - RC Rovere chiaro

Cassettiere su ruote

Struttura

Nobilitato melaminico di qualità E1, spessore cm 1.8. Dotate di 4 ruote in plastica pigmentata (ad alta durata) e di serratura con chiusura simultanea dei cassetti. Maniglia in zama con finitura nichel satinato.

Colori: WE Wengé

Parti frontali

Nobilitato melaminico di qualità E1. Spessore cm 1.8 con bordo ABS 15/10 stondato antiurto nelle parti verticali e altri bordi in ABS 6/10.

Colori: WE Wengé - RC Rovere chiaro

Boiserie

Struttura

Fianchi e traverso superiore realizzati in tamburato spessore cm 7.5 con bordo ABS 20/10 stondato antiurto. Basamento in nobilitato con finitura alluminio spessore cm 1.8 dotato di piedini di livellamento. Schienali in nobilitato melaminico di qualità E1 spessore cm 1.8, corredate di profili in alluminio predisposti all'aggancio delle mensole.

Colori: WE Wengé

Mensole nobilitato

Nobilitato melaminico di qualità E1. Spessore cm 2.8 corredate da un profilo in estruso di alluminio per l'aggancio sulle schiene strutturali.

Colori: WE Wengé - RC Rovere chiaro

Mensole in cristallo

Vetro temperato e serigrafato, spessore cm 1, corredate da un profilo in estruso di alluminio per l'aggancio sulle schiene strutturali.

Colori: R Rosso - M Moka - B Beige - S Satinato - W Bianco

Serventi

Struttura

Nobilitato melaminico di qualità E1, spessore cm 1.8.

Completati di serratura.

Colori: WE Wengé

Parti frontali

Nobilitato melaminico di qualità E1. Spessore cm 1.8 con bordo ABS 15/10 stondato antiurto nelle parti verticali e altri bordi in ABS 6/10. Maniglia in zama con finitura nichel satinato.

Colori: WE Wengé - RC Rovere chiaro

Top di finitura

Nobilitato melaminico di qualità E1, spessore cm 2.8.

Colori: WE Wengé - RC Rovere chiaro

Basamento in nobilitato

Nobilitato melaminico di qualità E1, spessore cm 1.8, dotato di piedini di livellamento.

Colori: Z Alluminio goffrato

Basamento in alluminio

Realizzato in estruso di alluminio con finitura satinata, dotato di 4 piedini livellatori alti cm 10 realizzati in pressofusione di alluminio.

Colori: Z Alluminio

Physical-mechanical characteristics of the melamine panels

Level of emission of formaldehyde: E1

Thickness: 1.2 – 1.8 – 2.8cm.

Density: 660 kg (± 3%) cu.m. (DIN68763/81)

Melamine worktops

Desks/Return tops/Meeting tables

E1 quality melamine.

2.8 cm thick with 20/10 rounded shockproof ABS edging on all 4 sides.

Colours: WE Wengé - RC Light oak

Workstation structure

Desks/Meeting tables

Honeycomb board panel legs 7.5cm thick with 20/10 rounded shockproof ABS edging. Melamine base with aluminium finish 1.8cm thick fitted with adjustable feet.

Colours: WE Wengé

E1 quality melamine panel connecting legs 1.8cm thick.

Colours: WE Wengé - RC Light oak

Worktop fixing brackets of pressure die-cast aluminium.

Colours: Z Embossed aluminium

Additional components for worktops

Desks/Return tops/Meeting tables

Finishing terminal units

Made of extruded aluminium complete with finishing caps made in Zn + Al + Mg alloy die-casting, all epoxy coated.

Colours: Z Embossed aluminium

Glass worktops

Tempered and screen printed glass, 1 cm thick, complete with slip-proof rubber edging for fixing to the desk top below. In the case of the worktops made up of two elements (meeting tables) an aluminium extruded profile with an embossed finish, complete with double sided tape to join the two components, is inserted.

Colours: R Red - M Coffee - B Beige - W White

Leather worktops

Made from an internal chipboard panel and covered in leather, complete with

slip-proof rubber edging for fixing to the desk top below.

Colours: R Red - M Coffee - B Beige - W White

Bearing drawer units

Structure

E1 quality melamine, 1.8cm. thick. Melamine base with aluminium finish 1.8cm thick fitted with adjustable feet.

Central locking of all drawers. Handle in Zn + Al + Mg

alloy with satined nickel finishing.

Colours: WE Wengé

Front

E1 quality melamine. 1.8cm thick with 15/10 rounded shockproof ABS edging on the vertical sides and 6/10 ABS edging on the other sides.

Colours: WE Wengé - RC Light oak

Drawer units on castors

Structure

E1 quality melamine, 1.8cm thick. Fitted with 4 pigmented plastic castors (long lasting) and lock with central locking of all drawers. Handle in Zn + Al + Mg alloy with satined nickel finishing.

Colours: WE Wengé

Front

E1 quality melamine. 1.8cm thick with 15/10 rounded shockproof ABS edging on the vertical sides and 6/10 ABS edging on the other sides.

Colours: WE Wengé - RC Light oak

Boiseries

Structure

Legs and upper beam made of honeycomb board panel legs 7.5 cm thick with 20/10 rounded shockproof ABS edging. Melamine base with aluminium finish 1.8cm thick fitted with adjustable feet.

E1 quality melamine back panels, 1.8cm thick, fitted with aluminium profiles predisposed for shelf fixing.

Colours: WE Wengé

Melamine shelves

E1 quality melamine, 2.8cm thick, fitted with an aluminium extruded profile for fixing to structural back panels.

Colours: WE Wengé - RC Light oak

Glass shelves

Tempered and screen printed glass, 1 cm thick, fitted with an aluminium extruded profile for fixing to structural back panels.

Colours: R Red - M Coffee - B Beige - S Satin - W White

Pedestals

Structure

E1 quality melamine, 1.8cm thick. Complete with locking.

Colours: WE Wengé

Front

E1 quality melamine. 1.8cm thick with 15/10 rounded shockproof ABS edging on the vertical sides and 6/10

Technical details

ABS edging on the other sides. Handle in Zn + Al + Mg alloy with satined nickel finishing.
Colours: WE Wengé - RC Light oak

Finishing top

E1 quality melamine, 2.8cm thick
Colours: WE Wengé - RC Light oak

Melamine base

E1 quality melamine, 1.8cm thick, fitted with adjustable feet.
Colours: Z Embossed aluminium

Aluminium base

Made of extruded aluminium with satin finish fitted with 4 10cm high adjustable feet made of pressure die-casting aluminium.
Colours: Z Aluminium

Caractéristiques techniques

Caractéristiques physico-mécaniques des panneaux en mélamine

Emission de formaldéhyde: E1

Épaisseur: 1,2 - 1,8 - 2,8 cm

Densité: 660 kg (± 3%) m³ (DIN 68763/81).

Plateaux en mélamine

Bureaux/Retours/Tables de réunion

Mélaminé de qualité E1.

Épaisseur 2,8 cm avec chant en ABS 20/10 arrondi antichoc sur 4 côtés.

Coloris: WE Wengé - RC Chêne clair

Structure postes de travail

Bureaux/Tables de réunion

Piètement plein réalisé en panneaux nid d'abeilles d'une épaisseur de 7,5 cm avec chant ABS 20/10 arrondi antichoc. Base en mélaminé avec finition en aluminium d'une épaisseur de 1,8 cm dotée de pieds de nivellement.

Coloris: WE Wengé

Panneaux de jonction piètement plein réalisés en mélaminé de qualité E1 d'une épaisseur de 1,8 cm.

Coloris: WE Wengé - RC Chêne clair

Supports de fixation plateaux réalisés en moulage sous pression d'aluminium.

Coloris: Z Aluminium gaufré

Éléments additionnels pour plateaux

Bureaux/Retours/Tables de réunion

Éléments terminaux de finition

Réalisés en extrudé d'aluminium avec des bouchons de finition réalisés en moulage de pression de zamac, le tout en laqué époxy.

Coloris: Z Aluminium gaufré

Plateaux vitrés

Verre trempé et sérigraphié, d'une épaisseur de 1 cm, muni de garniture en caoutchouc antidérapant pour le fixation au plateau du bureau placé en dessous. Pour les plateaux formés de deux éléments (tables de réunion) on insère un profil en extrudé d'aluminium avec finition gaufrée, doté de biadhésif pour la jonction des deux éléments.

Coloris: R Rouge - M Café - B Beige - W Blanc

Plateaux en cuir

Réalisés avec plateau interne en aggloméré et revêtement en peau, muni de garniture en caoutchouc antidérapant pour le fixation au plateau du bureau placé en dessous.

Coloris: R Rouge - M Café - B Beige - W Blanc

Caissons portants

Corps

Mélaminé de qualité E1, épaisseur 1,8 cm.

Base en mélaminé avec finition en aluminium d'une épaisseur de 1,8 cm dotée de pieds de nivellement.

Equipés de serrure centralisée. Poignée en zamac avec finition nickel satiné.

Coloris: WE Wengé

Façade

Mélaminé de qualité E1. Épaisseur 1,8 cm avec chant en ABS 15/10 arrondi antichoc dans les parties verticales et autres chants en ABS 6/10.

Coloris: WE Wengé - RC Chêne clair

Caissons sur roulettes

Corps

Mélaminé de qualité E1, épaisseur 1,8 cm.

Dotés de 4 roulettes en plastique pigmenté (usage intensif) et serrure centralisée. Poignée en zamac avec finition nickel satiné.

Coloris: WE Wengé

Façade

Mélaminé de qualité E1.

Épaisseur 1,8 cm avec chant en ABS 15/10 arrondi antichoc dans les parties verticales et autres chants en ABS 6/10.

Coloris: WE Wengé - RC Chêne clair

Boiseries

Structure

Côtés et traverse supérieure réalisés en panneaux nid d'abeilles d'une épaisseur de 7,5 cm avec chant ABS 20/10 arrondi antichoc. Base en mélaminé avec finition en aluminium d'une épaisseur de 1,8 cm dotée de pieds de nivellement.

Panneaux de fond en mélaminé de qualité E1 d'une épaisseur de 1,8 cm dotés de profils en extrudé d'aluminium prédisposés pour l'accrochage des étagères.

Coloris: WE Wengé

Etagères en mélamine

Mélaminé de qualité E1 d'une épaisseur de 2,8 cm, dotées d'un profil en extrudé d'aluminium pour l'accrochage aux panneaux de fond.

Coloris: WE Wengé - RC Chêne clair

Etagères vitrées

Verre trempé et sérigraphié, d'une épaisseur de 1 cm, dotées d'un profil en extrudé d'aluminium pour l'accrochage aux panneaux de fond.

Coloris: R Rouge - M Café - B Beige - S Satiné - W Blanc

Caractéristiques techniques

Dessertes

Corps

Mélaminé de qualité E1, épaisseur 1,8 cm. Equipées de serrure centralisée.

Coloris: WE Wengé

Façade

Mélaminé de qualité E1. Epaisseur 1,8 cm avec chant en ABS 15/10 arrondi antichoc dans les parties verticales et autres chants en ABS 6/10. Poignée en zamac avec finition nickel satiné.

Coloris: WE Wengé - RC Chêne clair

Plateau de finition

Mélaminé de qualité E1, d'une épaisseur de 2,8 cm.

Coloris: WE Wengé - RC Chêne clair

Base en mélamine

Mélaminé de qualité E1, épaisseur 1,8 cm, doté de pieds de nivellement.

Coloris: Z Aluminium gaufré

Base en aluminium

Réalisée en extrudé d'aluminium avec finition satinée dotée de 4 pieds de nivellement de 10 cm de hauteur réalisés en moulage sous pression d'aluminium.

Coloris: Z Aluminium

Características técnicas

Características físico-mecánicas de los paneles melamínicos

Emisión de formaldehído: E1

Grosos: 1,2 – 1,8 – 2,8 cm.

Densidad 660 Kg. (± 3%) m³ (DIN 68763/81)

Superficies melamínicas

Escritorios/Extensiones/Mesas de reuniones

Melamina de calidad E1.

Grosor 2,8 cm. con borde en ABS 20/10 curvo a prueba de golpes en los 4 lados.

Colores: WE Wengé - RC Roble claro

Estructura lugares de trabajo

Escritorios/Mesas de reuniones

Costados realizados con paneles de estructura alveolar, grosor 7,5 cm con borde en ABS 20/10 curvo a prueba de golpes. Base de melamina con acabado satinado, grosor 1,8 cm., dotada de patas regulables.

Colores: WE Wengé

Paneles de conexión con los costados realizados en melamina de calidad E1, grosor 1,8 cm.

Colores: WE Wengé - RC Roble claro

Soportes de sujeción superficies realizados en aluminio de vaciado a presión.

Colores: Z Aluminio gofrado

Componentes añadidos para superficies

Escritorios/Extensiones/Mesas de reuniones

Cabezales de acabado

Realizados en extrusionado de aluminio con tapas de acabado de zama de vaciado a presión pintadas con polvos epoxídicos.

Colores: Z Aluminio gofrado

Superficies de cristal

Cristal templado y serigrafiado, grosor 1 cm., con guarnición de goma antideslizante para sujetarlo a la superficie del escritorio. En las superficies formadas por dos componentes (mesas de reuniones) se introduce un perfil de extrusionado de aluminio con acabado gofrado, dotado de biadhesivo para que se unan los dos componentes.

Colores: R Rojo - M Moka - B Beige - W Blanco

Superficies de piel

Realizadas con superficie interior de conglomerado revestido en piel, con guarnición de goma antideslizante para sujetarla a la superficie del escritorio.

Colores: R Rojo - M Moka - B Beige - W Blanco

Cajoneras portantes

Estructura

Melamina de calidad E1, grosor 1,8 cm. Base de melamina con acabado de aluminio, grosor 1,8 cm., con patas regulables y cerradura con cierre simultáneo de los cajones. Manilla de zama con acabado de níquel satinado.

Colores: WE Wengé

Frontales

Melamina de calidad E1. Grosor 1,8 cm. con borde ABS 15/10 curvo a prueba de golpes en las partes verticales y otros bordes de ABS 6/10.

Colores: WE Wengé - RC Roble claro

Cajoneras con ruedas

Estructura

Melamina de calidad E1, grosor 1,8 cm.

Dotadas de 4 ruedas de plástico pigmentado (de larga duración) y cerradura con cierre simultáneo de los cajones. Manilla de zama con acabado de níquel satinado.

Colores: WE Wengé

Frontales

Melamina de calidad E1. Grosor 1,8 cm. con borde ABS 15/10 curvo a prueba de golpes en las partes verticales y otros bordes de ABS 6/10.

Colores: WE Wengé - RC Roble claro

Boiserie

Estructura

Costados y travesaño superior realizados con paneles de estructura alveolar, grosor 7,5 cm con borde en ABS 20/10 curvo a prueba de golpes. Base de melamina con acabado satinado de 1,8 cm. de grosor dotada de patas regulables.

Paneles posteriores de melamina de calidad E1, grosor 1,8 cm., con perfiles de aluminio preparados para enganchar los estantes.

Colores: WE Wengé

Estantes melamínicos

Melamina de calidad E1, grosor 1,8 cm., con un perfil de extrusionado de aluminio para enganchar en los paneles posteriores estructurales.

Colores: WE Wengé - RC Roble claro

Estantes de cristal

Cristal templado y serigrafiado, grosor 1 cm., con un perfil de extrusionado de aluminio para enganchar en los paneles posteriores estructurales.

Colores: R Rojo - M Moka - B Beige - S Satinado - W Blanco

Características técnicas

Pedestales

Estructura

Melamina de calidad E1, grosor 1,8 cm., con cerradura.

Colores: WE Wengé

Frontales

Melamina de calidad E1. Grosor 1,8 cm. con borde ABS 15/10 curvo a prueba de golpes en las partes verticales y otros bordes de ABS 6/10. Manilla de zama con acabado de níquel satinado.

Colores: WE Wengé - RC Roble claro

Superficie de acabado

Melamina de calidad E1, grosor 2,8 cm.

Colores: WE Wengé - RC Roble claro

Base melamínica

Melamina de calidad E1, grosor 1,8 cm. dotada de patas regulables.

Colores: Z Aluminio gofrado

Base de aluminio

Realizada en extrusionado de aluminio con acabado satinado dotada de 4 patas regulables de 10 cm de altura realizadas en aluminio de vaciado a presión.

Colores: Z Aluminio

Peso, volume e colli
 Weight, volume and packages
 Poids, volume et colis
 Peso, volumen y bultos

Codice Code Code Código	Peso Weight Poids Peso kg	Volume Volume Volumen m ³	Colli Packages Colis Bultos n°	Codice Code Code Código	Peso Weight Poids Peso kg	Volume Volume Volumen m ³	Colli Packages Colis Bultos n°	Codice Code Code Código	Peso Weight Poids Peso kg	Volume Volume Volumen m ³	Colli Packages Colis Bultos n°
13459	2	0,01	1	40063V	37	0,07	2	40136	21	0,2	2
13776	0,15	0,002	1	40067P	8	0,03	2	40137	21	0,2	2
13777	0,15	0,002	1	40067V	42	0,08	2	40138	24	0,18	1
13778	0,9	0,005	1	40068P	8	0,03	2	40142	28	0,35	1
13779	0,3	0,001	1	40068V	42	0,08	2	40143	34	0,38	2
13780	1	0,01	1	40072P	9	0,03	2	40148	14	0,035	3
40001	72	0,186	5	40072V	52	0,11	2	40149	22	0,05	4
40002	79	0,2	5	40073P	11	0,04	2	40150	29	0,065	4
40006	81	0,21	5	40073V	67	0,12	2	40154	14	0,035	2
40010	57	0,136	5	40077	92	0,25	5	40155	22	0,05	2
40011	64	0,15	5	40081	109	0,32	10	40156	29	0,065	2
40015	66	0,16	5	40085	169	0,48	15	40160	163	0,15	5
40019	42	0,086	4	40090	59	0,15	5	40161N	15	0,03	1
40020	49	0,1	4	40098P	17	0,05	2	40161V	18	0,05	2
40024	51	0,11	4	40098V	102	0,21	2				
40028	3	0,014	1	40102P	22	0,065	3				
40032P	12	0,055	2	40102V	152	0,27	4				
40032V	67	0,135	2	40106P	32	0,07	4				
40033P	13	0,065	2	40106V	232	0,4	6				
40033V	82	0,165	2	40110P	10	0,03	1				
40037P	14	0,075	2	40110V	80	0,13	2				
40037V	87	0,175	2	40114	6	0,025	2				
40041	26	0,07	4	40115	11	0,035	2				
40045	37	0,078	6	40120	56	0,33	1				
40046	45	0,085	6	40121	56	0,33	1				
40047	37	0,078	7	40125	28	0,18	1				
40048	45	0,085	7	40126	28	0,18	1				
40050	38	0,11	4	40127	25	0,18	1				
40051	38	0,11	4	40128	28	0,18	2				
40055	2,5	0,011	1	40129	28	0,18	2				
40059	1,5	0,013	1	40130	25	0,18	2				
40063P	7	0,02	2	40135	17	0,18	1				

ABC

Abbinamenti colore e come ordinare
Colour matching and how to order
Association coloris et comment passer la commande
Combinación de colores y modo de hacer pedidos

- 13 Scrivanie e tavoli riunione
Desks and meeting tables
Bureaux et tables reunion
Escritorios y mesas de reuniones
- 14 Elementi aggiuntivi per scrivanie
Additional components for desks
Elements additionnels pour bureaux
Componentes añadidos para escritorios
- 15 Cassettiere portanti / Cassettiere su ruote
Bearing drawer units / Drawer units on castors
Caissons portants / Caissons sur roulettes
Caioneras portantes / Cajoneras con ruedas
- 16 Serventi
Pedestals
Dessertes
Pedestales

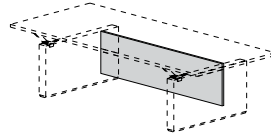
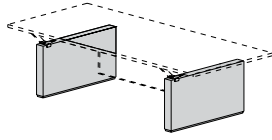
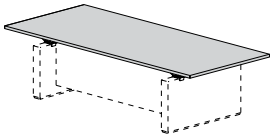

Piano
Worktop
Plateau
Superficie

WE Wengé
 Wengé
 Wengé
 Wengé

RC Rovere chiaro
 Light oak
 Chêne clair
 Roble claro

Fianchi
Panel legs
Piètement plein
Patas de panel

WE Wengé
 Wengé
 Wengé
 Wengé

Pannello
Modesty panel
Voile de fond
Faldón

WE Wengé
 Wengé
 Wengé
 Wengé

RC Rovere chiaro
 Light oak
 Chêne clair
 Roble claro

Per una corretta compilazione dell'ordine bisogna indicare:
 - colore piano/pannello
 - codice prodotto
 - colore fianchi

Esempio:
 Scrivania rettangolare 180x90 con piano in nobilitato rovere chiaro e fianchi wengé

- Sigla piano/pannello rovere chiaro RC
- Codice prodotto 40001
- Sigla fianchi wengé WE

Compilation of the order must indicate:
 - colour of the worktop/modesty panel
 - product code
 - colour of the panel legs

Example:
 180x90 rectangular desk with melamine worktop in a light oak finish and panel legs in a wengé finish

- Light oak worktop/modesty panel RC
- Code 40001
- Wengé panel legs WE

Pour rédiger la commande il faut indiquer:
 - coloris plateau/voile de fond
 - code produit
 - coloris piètement plein

Exemple:
 Bureau rectangulaire 180x90 avec plateau en mélamine coloris chêne clair et piètement plein coloris wengé

- Plateau/voile de fond chêne clair RC
- Code 40001
- Piètement plein wengé WE

Para rellenar el impreso del pedido hay que indicar:
 - color de la superficie/faldón
 - código del producto
 - color de las patas de panel

Ejemplo:
 Escritorio rectangular 180x90 con superficie de melamina color roble claro y patas de panel color wengé

- Superficie/faldón roble claro RC
- Código 40001
- Patas de panel wengé WE

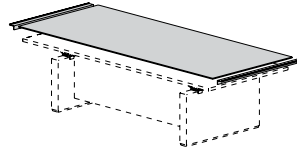
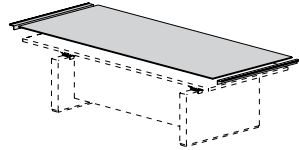
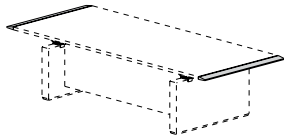

Testate terminali
Terminal elements
Eléments terminaux
Cabezales

Z Alluminio
 Aluminium
 Aluminium
 Aluminio

Piani in cristallo (V)
Glass worktops (V)
Plateaux vitrés (V)
Superficies de cristal (V)

RD Rosso
 Red
 Rouge
 Rojo

M Moka
 Coffee
 Café
 Moka

B Beige
 Beige
 Beige
 Beige

W Bianco
 White
 Blanc
 Blanco

Piani in pelle (P)
Leather worktops (P)
Plateaux en cuir (P)
Superficies de piel (P)

RD Rosso
 Red
 Rouge
 Rojo

M Moka
 Coffee
 Café
 Moka

B Beige
 Beige
 Beige
 Beige

W Bianco
 White
 Blanc
 Blanco

Per una corretta
 compilazione dell'ordine
 bisogna indicare:
 - colore piano in cristallo/
 pelle
 - codice prodotto
 - sigla materiale

Esempio:
 Piano in cristallo moka
 per scrivania rettangolare
 210x90

- Sigla piano moka M
- Codice prodotto 40033
- Sigla materiale V

Compilation of the order
 must indicate:
 - colour of the glass
 worktop/leather worktop
 - product code
 - material code

Example:
 Glass worktop in a coffee
 finish for a 210x90
 rectangular desk

- Coffee worktop M
- Code 40033
- Material code V

Pour rédiger la commande
 il faut indiquer:
 - coloris plateau vitré/en
 cuir
 - code produit
 - code matériel

Exemple:
 Plateau vitré coloris café
 pour bureau rectangulaire
 210x90

- Plateau café M
- Code 40033
- Code matériel V

Para rellenar el impreso de
 pedido hay que indicar:
 - color de la superficie de
 cristal/de piel
 - código del producto
 - código material

Ejemplo:
 Superficie de cristal color
 moka para escritorio
 rectangular 210x90

- Superficie moka M
- Código 40033
- Código material V

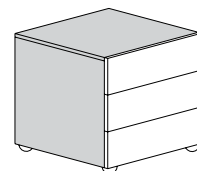
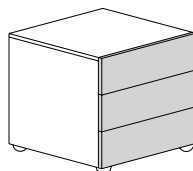
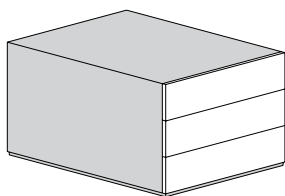
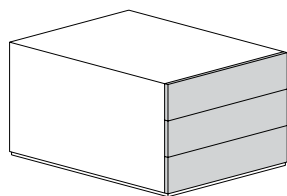

Frontale
 Front
 Façade
 Frontal

Struttura
 Structure
 Corps
 Estructura

Frontale
 Front
 Façade
 Frontal

Struttura
 Structure
 Corps
 Estructura

WE Wengé
 Wengé
 Wengé
 Wengé

WE Wengé
 Wengé
 Wengé
 Wengé

WE Wengé
 Wengé
 Wengé
 Wengé

WE Wengé
 Wengé
 Wengé
 Wengé

RC Rovere chiaro
 Light oak
 Chêne clair
 Roble claro

RC Rovere chiaro
 Light oak
 Chêne clair
 Roble claro

Per una corretta compilazione dell'ordine bisogna indicare:
 - colore frontale
 - codice prodotto
 - colore struttura

Esempio:
 Cassettiera portante con 3 cassetti con frontali in nobilitato colore rovere chiaro

- Sigla frontale rovere chiaro RC
 - Codice prodotto 40120
 - Sigla struttura wengé WE

Compilation of the order must indicate:
 - front colour
 - product code
 - colour of the structure

Example:
 Bearing drawer unit with 3 drawers with melamine front in a light oak finish

- Light oak front RC
 - Code 40120
 - Wengé structure WE

Pour rédiger la commande il faut indiquer:
 - coloris façade
 - code produit
 - coloris corps

Exemple:
 Caisson portant à 3 tiroirs avec façade en mélamine coloris chêne clair

- Façade chêne clair RC
 - Code 40120
 - Corps en wengé WE

Para rellenar el impreso del pedido hay que indicar:
 - color del frontal
 - código del producto
 - color de la estructura

Ejemplo:
 Cajonera portante con 3 cajones con frontal melamínico color roble claro

- Frontal roble claro RC
 - Código 40120
 - Estructura wengé WE

Serventi
 Pedestals
 Dessertes
 Pedestales

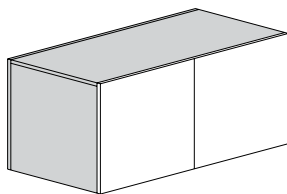
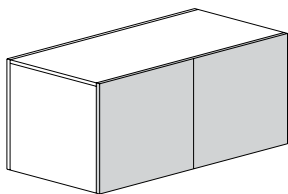

Frontale
 Front
 Façade
 Frontal

WE Wengé
 Wengé
 Wengé
 Wengé

RC Rovere chiaro
 Light oak
 Chêne clair
 Roble claro

Struttura
 Structure
 Corps
 Estructura

WE Wengé
 Wengé
 Wengé
 Wengé

Per una corretta compilazione dell'ordine bisogna indicare:

- colore frontale
- codice prodotto
- colore struttura

Esempio:
 Servente L 100/H 55 con 2 ante in nobilitato colore rovere chiaro

- Sigla frontale rovere chiaro RC
- Codice prodotto 40143
- Sigla struttura wengé WE

Compilation of the order must indicate:

- front colour
- product code
- colour of the structure

Example:
 Pedestal L 100 H.55 with 2 doors in a melamine light oak finish

- Light oak front RC
- Code 40143
- Wengé structure WE

Pour rédiger la commande il faut indiquer:

- coloris façade
- code produit
- coloris corps

Exemple:
 Desserte L 100 H.55 avec 2 portes en mélaminé coloris chêne clair

- Façade chêne clair RC
- Code 40143
- Corps en wengé WE

Para rellenar el impreso del pedido hay que indicar:

- color del frontal
- código del producto
- color de la estructura

Ejemplo:
 Pedestal L 100 y A.55 con 2 puertas de melamínico color roble claro

- Frontal roble claro RC
- Código 40143
- Estructura wengé WE

Esplicativo componibilità top access
Access top compositions details
Détails de composition pour top access
Explicativo de la composición para top access

DESCRIZIONE

Il programma Abc prevede di poter intercambiare e/o modificare, in qualsiasi momento, i piani lavoro senza arrecare danneggiamenti ai componenti stessi.

The Abc range includes the possibility of interchanging and/or modifying, at any time, the worktops without damaging the components in any way.

Grâce au programme Abc il est possible de changer et / ou de modifier les plateaux, à n'importe quel moment et sans leur causer aucun dommage.

El programa Abc prevé poder intercambiar y/o modificar, en cualquier momento, las superficies sin causar daño a los componentes de los mismos.

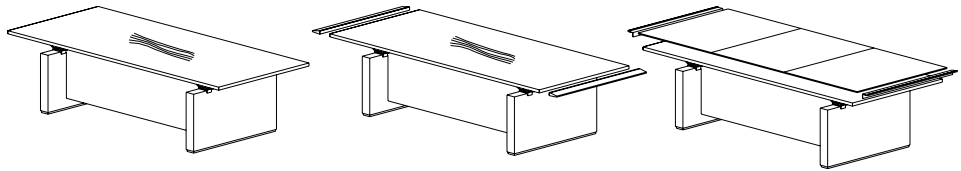

Scrivanía con piano in nobilitato
Desk with melamine worktop
Bureau avec plateau en mélamine
Escritorio con superficie de melamina

Scrivanía con piano in nobilitato completo di testate terminali
Desk with melamine worktop complete with terminal elements
Bureau avec plateau en mélamine muni d'éléments terminaux
Escritorio con superficie de melamina con cabezales terminales

Scrivanía con piano in nobilitato completa di piano aggiuntivo in pelle o cristallo
Desk with melamine worktop complete with additionnel leather or glass worktop
Bureau avec plateau en mélamine muni de plateau additionnel en cuir ou vitre
Escritorio con superficie de melamina con superficie añadida de piel o cristal

ABC

ELEMENTO

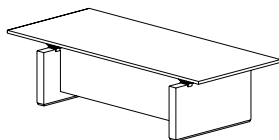

DESCRIZIONE

Scrivania rettangolare con fianchi in tamburato
 Rectangular desk with honeycomb board panel legs
 Bureau rectangulaire avec piétement plein en panneaux nid d'abeilles
 Escritorio rectangular con patas de panel de estructura alveolar

		Piano nobilitato Melamine worktop / Plateau en mélamine / Superficie melamínica			
		WE wengé wengé wengé wengé	RC rovere chiaro light oak chêne clair roble claro		
MISURA	CODICE				
180x90	40001	1.266,00	1.304,00		
210x90	40002	1.307,00	1.349,00		

ELEMENTO

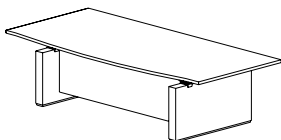

DESCRIZIONE

Scrivania sagomata con fianchi in tamburato
 Workstation desk with honeycomb board panel legs
 Bureau compact avec piétement plein en panneaux nid d'abeilles
 Escritorio compacto con patas de panel de estructura alveolar

		Piano nobilitato Melamine worktop / Plateau en mélamine / Superficie melamínica			
		WE wengé wengé wengé wengé	RC rovere chiaro light oak chêne clair roble claro		
MISURA	CODICE				
210x97	40006	1.317,00	1.357,00		

ELEMENTO

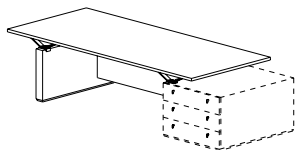

DESCRIZIONE

Scrivania rettangolare predisposta per 1 cassetiera portante
(ordinare cassetiera portante pag. 34)
Rectangular desk predisposed for 1 bearing drawer unit
(order bearing drawer unit page 34)
Bureau rectangulaire prévu pour 1 caisson portant
(commander caisson portant page 34)
Escritorio rectangular preparado para 1 cajonera portante
(pedir cajonera portante página 34)

		Piano nobilitato Melamine worktop / Plateau en mélamine / Superficie melamínica			
		WE wengé wengé wengé wengé	RC rovere chiaro light oak chêne clair roble claro		
MISURA	CODICE				
208x90	40010	939,00	969,00		
238x90	40011	983,00	1.012,00		

ELEMENTO

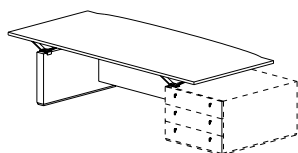

DESCRIZIONE

Scrivania sagomata predisposta per 1 cassetiera portante
(ordinare cassetiera portante pag. 34)
Workstation desk predisposed for 1 bearing drawer unit
(order bearing drawer unit page 34)
Bureau compact prévu pour 1 caisson portant
(commander caisson portant page 34)
Escritorio compacto preparado para 1 cajonera portante
(pedir cajonera portante página 34)

		Piano nobilitato Melamine worktop / Plateau en mélamine / Superficie melamínica			
		WE wengé wengé wengé wengé	RC rovere chiaro light oak chêne clair roble claro		
MISURA	CODICE				
238x97	40015	993,00	1.022,00		

ELEMENTO

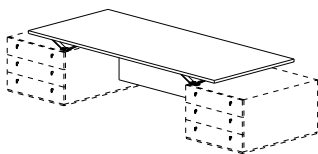

DESCRIZIONE

Scrivania rettangolare predisposta per 2 cassettiere portanti
(ordinare cassettiere portanti pag. 34)
Rectangular desk predisposed for 2 bearing drawer units
(order bearing drawer units page 34)
Bureau rectangulaire prévu pour 2 caissons portants
(commander caissons portants page 34)
Escritorio rectangular preparado para 2 cajoneras portantes
(pedir cajoneras portantes página 34)

		Piano nobilitato Melamine worktop / Plateau en mélamine / Superficie melamínica			
		WE wengé wengé wengé wengé	RC rovere chiaro light oak chêne clair roble claro		
MISURA	CODICE				
235x90	40019	570,00	587,00		
265x90	40020	611,00	628,00		

ELEMENTO

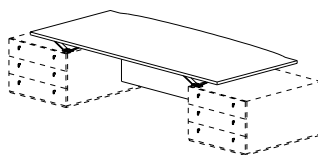

DESCRIZIONE

Scrivania sagomata predisposta per 2 cassettiere portanti
(ordinare cassettiere portanti pag. 3)
Workstation desk predisposed for 2 bearing drawer units
(order bearing drawer units page 34)
Bureau compact prévu pour 2 caissons portants
(commander caissons portants page 34)
Escritorio compacto preparado para 2 cajoneras portantes
(pedir cajoneras portantes página 34)

		Piano nobilitato Melamine worktop / Plateau en mélamine / Superficie melamínica			
		WE wengé wengé wengé wengé	RC rovere chiaro light oak chêne clair roble claro		
MISURA	CODICE				
265x97	40024	622,00	641,00		

Elementi aggiuntivi per scrivanie
 Additional components for desks
 Eléments additionnels pour bureaux
 Componentes añadidos para escritorios

ELEMENTO

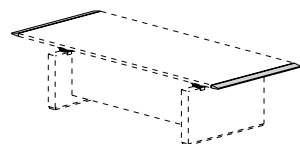

DESCRIZIONE

Coppia testate terminali (lato cm 90) per piani scrivania
 Pair of terminal elements (90cm side) for desk worktops
 Paire d'éléments terminaux (côté 90 cm) pour plateaux bureau
 Par de cabezales terminales (lado 90 cm) para superficies escritorio

		Estruso di alluminio Extruded aluminium / Extrude d'aluminium / Extrusionado de aluminio			
		Z alluminio gofrato goffered aluminium aluminium gaufré aluminio gofrado			
MISURA	CODICE				
90x10	40028	111,00			

ELEMENTO

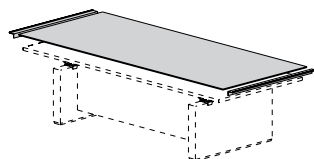

DESCRIZIONE

Piano aggiuntivo per scrivanie rettangolari
 Additional worktop for rectangular desks
 Plateau additionnel pour bureaux rectangulaires
 Superficie añadida para escritorios rectangulares

		Cristallo Glass / Vitre / Cristal				Pelle Leather / Cuir / Piel			
		R rosso red rouge rojo	M moka coffee café moka	B beige beige beige beige	W bianco white blanc blanco	R rosso red rouge rojo	M moka coffee café moka	B beige beige beige beige	W bianco white blanc blanco
MISURA	CODICE								
188x90	40032	695,00	695,00	695,00	695,00	1.068,00	1.068,00	1.068,00	1.068,00
218x90	40033	782,00	782,00	782,00	782,00	1.153,00	1.153,00	1.153,00	1.153,00

ABC

ELEMENTO

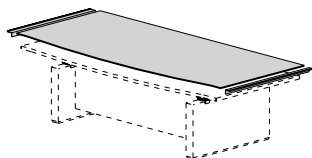

DESCRIZIONE

Piano aggiuntivo sagomato per scrivanie sagomate
 Additional shaped worktop for workstations
 Plateau multiforme additionnel pour bureaux compacts
 Superficie multiforme añadida para escritorios compactos

MISURA	CODICE	Cristallo Glass / Vitre / Cristal				Pelle Leather / Cuir / Piel			
		R rosso red rouge rojo	M moka coffee café moka	B beige beige beige beige	W bianco white blanc blanco	R rosso red rouge rojo	M moka coffee café moka	B beige beige beige beige	W bianco white blanc blanco
218x97	40037	878,00	878,00	878,00	878,00	1.215,00	1.215,00	1.215,00	1.215,00

ELEMENTO

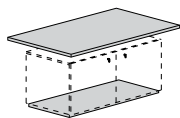

DESCRIZIONE

Piano dattilo completo di basamento (cm 100) per serventi
(ordinare serventi pag. 44)
Typing table worktop complete with base (100cm) for pedestals
(order pedestals page 44)
Plateau bureau informatique muni de base (100 cm) pour dessertes
(commander dessertes page 44)
Superficie d'áctilo con base (100 cm) para pedestales
(pedir pedestales página 44)

		Piano nobilitato Melamine worktop / Plateau en mélamine / Superficie melamínica			
		WE wengé wengé wengé wengé	RC rovere chiaro light oak chêne clair roble claro		
MISURA	CODICE				
120x70	40041	309,00	320,00		

ELEMENTO

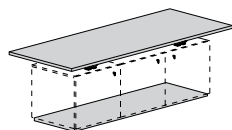

DESCRIZIONE

Piano consolle completo di basamento (cm 150/200) per serventi
(ordinare serventi pag. 44)
Console worktop complete with base (150/200cm) for pedestals
(order pedestals page 44)
Plateau console muni de base (150/200 cm) pour dessertes
(commander dessertes page 44)
Superficie consola con base (150/200) para pedestales
(pedir pedestales página 44)

		Piano nobilitato Melamine worktop / Plateau en mélamine / Superficie melamínica			
		WE wengé wengé wengé wengé	RC rovere chiaro light oak chêne clair roble claro		
MISURA	CODICE				
180x70	40045	501,00	516,00		
220x70	40046	557,00	575,00		

ELEMENTO

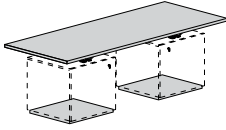

DESCRIZIONE

Piano consolle completo di 2 basamenti (cm 50) per serventi (ordinare serventi pag. 44)
 Console worktop complete with 2 bases (50 cm) for pedestals (order pedestals page 44)
 Plateau consolle muni de 2 bases (50 cm) pour dessertes (commander dessertes page 44)
 Superficie consola con 2 bases (50 cm) para pedestales (pedir pedestales página 44)

		Piano vetro Glass worktop / Plateau en verre / Superficie de cristal			
		WE wengé wengé wengé wengé	RC rovere chiaro light oak chêne clair roble claro		
MISURA	CODICE				
180x70	40047	508,00	524,00		
220x70	40048	555,00	572,00		

Complanari / Elementi aggiuntivi per complanari
 Return tops / Additional components for return tops
 Retours / Eléments additionnels pour retours
 Extensiones / Componentes añadidos para extensiones

ELEMENTO

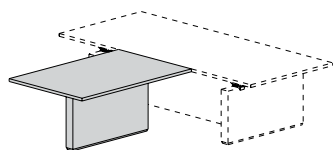

DESCRIZIONE

Allungo per riunioni
 Return top for meetings
 Retour pour réunions
 Componente para reuniones

SCRIVANIA RETTANGOLARE
 RECTANGULAR DESK
 BUREAU RECTANGULAIRE
 ESCRITORIO RECTANGULAR

MISURA CODICE

120x80

40050

Piano nobilitato
 Melamine worktop / Plateau en mélamine / Superficie melamínica

WE
 wengé
 wengé
 wengé
 wengé

RC
 rovere chiaro
 light oak
 chêne clair
 roble claro

587,00

605,00

SCRIVANIA SAGOMATA
 WORKSTATION DESK
 BUREAU COMPACT
 ESCRITORIO COMPACTO

120x80

40051

623,00

643,00

ELEMENTO

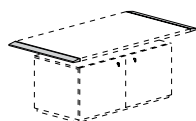

DESCRIZIONE

Coppia testate terminali (lato cm 70) per piani dattilo e console
 Pair of terminal elements (70cm side) for typing table and console worktops
 Paire d'éléments terminaux (côté 70 cm) pour plateaux bureau informatique et console
 Par de cabezales terminales (lado 70 cm) para superficies d'actilo y consola

MISURA CODICE

70x10

40055

Estruso di alluminio
 Extruded aluminium / Extrude d'aluminium / Extrusionado de aluminio

Z
 alluminio gofrato
 goffered aluminium
 aluminium gaufré
 aluminio gofrado

102,00

Complanari / Elementi aggiuntivi per complanari
 Return tops / Additional components for return tops
 Retours / Eléments additionnels pour retours
 Extensiones / Componentes añadidos para extensiones

ELEMENTO

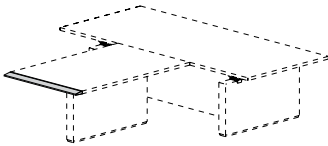

DESCRIZIONE

Testata terminale singola per allungo riunioni
 Single terminal element for return top for meetings
 Élément terminal simple pour retour réunions
 Cabezal terminal individual para componente para reuniones

MISURA	CODICE	Estruso di alluminio Extruded aluminium / Extrude d'aluminium / Extrusionado de aluminio			
		Z alluminio gofrato goffered aluminium aluminium gaufré aluminio gofrado			
80x10	40059	56,00			

Elementi aggiuntivi per complanari
 Additional components for return tops
 Eléments additionnels pour retours
 Componentes añadidos para extensiones

ELEMENTO

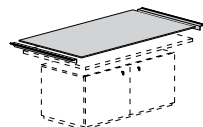

DESCRIZIONE

Piano aggiuntivo per dattilo
 Additional worktop for typing table
 Plateau additionnel pour bureau informatique
 Superficie añadida para dactilo

MISURA	CODICE	Cristallo Glass / Vitre / Cristal				Pelle Leather / Cuir / Piel			
		R rosso red rouge rojo	M moka coffee café moka	B beige beige beige beige	W bianco white blanc blanco	R rosso red rouge rojo	M moka coffee café moka	B beige beige beige beige	W bianco white blanc blanco
128x70	40063	423,00	423,00	423,00	423,00	794,00	794,00	794,00	794,00

ELEMENTO

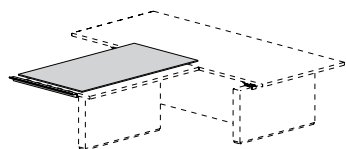

DESCRIZIONE

Piano aggiuntivo per allungo riunioni
 Additional worktop for return top for meetings
 Plateau additionnel pour retour réunions
 Superficie añadida para componente para reuniones

MISURA	CODICE	Cristallo Glass / Vitre / Cristal				Pelle Leather / Cuir / Piel			
		R rosso red rouge rojo	M moka coffee café moka	B beige beige beige beige	W bianco white blanc blanco	R rosso red rouge rojo	M moka coffee café moka	B beige beige beige beige	W bianco white blanc blanco
SCRIVANIA RETTANGOLARE RECTANGULAR DESK BUREAU RECTANGULAIRE ESCRITORIO RECTANGULAR	120x74 40067	459,00	459,00	459,00	459,00	774,00	774,00	774,00	774,00
SCRIVANIA SAGOMATA WORKSTATION DESK BUREAU COMPACT ESCRITORIO COMPACTO	120x74 40068	515,00	515,00	515,00	515,00	774,00	774,00	774,00	774,00

ABC

Elementi aggiuntivi per complanari
 Additional components for return tops
 Éléments additionnels pour retours
 Componentes añadidos para extensiones

ELEMENTO

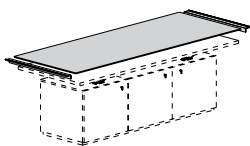

DESCRIZIONE

Piano aggiuntivo per consolle
 Additional worktop for console
 Plateau additionnel pour console
 Superficie añadida para consola

MISURA	CODICE	Cristallo Glass / Vitre / Cristal				Pelle Leather / Cuir / Piel			
		R rosso red rouge rojo	M moka coffee café moka	B beige beige beige beige	W bianco white blanc blanco	R rosso red rouge rojo	M moka coffee café moka	B beige beige beige beige	W bianco white blanc blanco
188x70	40072	572,00	572,00	572,00	572,00	971,00	971,00	971,00	971,00
228x70	40073	662,00	662,00	662,00	662,00	1.058,00	1.058,00	1.058,00	1.058,00

Zona di attesa
 Waiting area
 Zone d'accueil
 Zona de espera

ELEMENTO

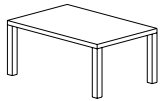

DESCRIZIONE

Tavolo fumo H 40
 H 40 smoking table
 Table basse H 40
 Mesita baja H 40

		Piano nobilitato Melamine worktop / Plateau en mélamine / Superficie melaminica			
		WE wengé wengé wengé wengé	RC rovere chiaro light oak chêne clair roble claro		
MISURA	CODICE				
60x60	40114	426,00	438,00		
120x60	40115	446,00	461,00		

ELEMENTO

DESCRIZIONE

Il programma Abc consente di allungare i tavoli riunione componibili tramite il codice 40090.
The Abc programme includes the possibility of extending the modular meeting tables using code 40090.
Le programme Abc permet de rallonger les tables de réunion à éléments au moyen du code 40090.
El programa Abc permite alargar las mesas de reuniones componibles usando el código 40090.

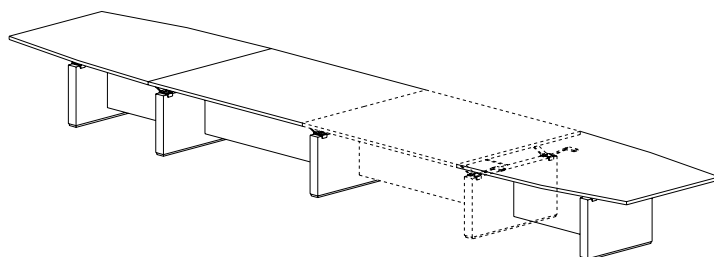

ELEMENTO

DESCRIZIONE

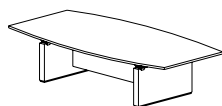

Tavolo riunione singolo sagomato
Shaped single meeting table
Table de réunion multiforme simple
Mesa de reuniones multiforme individual

		Piano nobilitato Melamine worktop / Plateau en mélamine / Superficie melamínica			
		WE wengé wengé wengé wengé	RC rovere chiaro light oak chêne clair roble claro		
MISURA	CODICE				
240x120	40077	1.372,00	1.413,00		

ELEMENTO

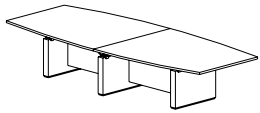

DESCRIZIONE

Tavolo riunione componibile sagomato
Shaped modular meeting table
Table de réunion à éléments multiforme
Mesa de reuniones componibile multiforme

		Piano nobilitato Melamine worktop / Plateau en mélamine / Superficie melamínica			
		WE wengé wengé wenge wengé	RC rovere chiaro light oak chêne clair roble claro		
MISURA	CODICE				
300x120	40081	1.966,00	2.025,00		

ELEMENTO

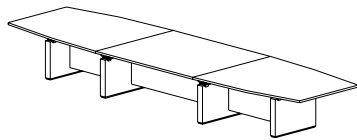

DESCRIZIONE

Tavolo riunione componibile sagomato
Shaped modular meeting table
Table de réunion à éléments multiforme
Mesa de reuniones componibile multiforme

		Piano nobilitato Melamine worktop / Plateau en mélamine / Superficie melamínica			
		WE wengé wengé wengé wengé	RC rovere chiaro light oak chêne clair roble claro		
MISURA	CODICE				
450x120	40085	2.773,00	2.857,00		

ABC

ELEMENTO

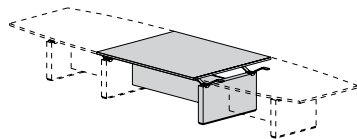

DESCRIZIONE

Allungo per tavolo riunione componibile
Table component for modular meeting table
Table de réunion à éléments multiforme
Componente para mesa reuniones componibile

		Piano nobilitato Melamine worktop / Plateau en mélamine / Superficie melamínica			
		WE wengé wengé wengé wengé	RC rovere chiaro light oak chêne clair roble claro		
MISURA	CODICE				
150x120	40090	810,00	835,00		

Elementi aggiuntivi per tavoli riunione
 Additional components for meeting tables
 Éléments additionnels pour tables réunion
 Componentes añadidos para mesas de reuniones

ELEMENTO



DESCRIZIONE

Coppia testate terminali (lato cm 90) per piani tavolo riunione
 Pair of terminal elements (90cm side) for meeting table worktops
 Paire d'éléments terminaux (côté 90 cm) pour plateaux table de réunion
 Par de cabezales terminales (lado 90 cm) para superficies mesa de reuniones

MISURA		CODICE		DESCRIZIONE			
90x10		40028		Estruso di alluminio Extruded aluminium / Extrude d'aluminium / Extrusionado de aluminio			
				Z alluminio gofrato goffered aluminium aluminium gaufré aluminio gofrado			
				111,00			

ELEMENTO

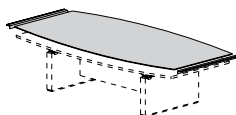

DESCRIZIONE

Piano aggiuntivo per tavolo riunione (cm 240x120) singolo sagomato
 Additional worktop for 240x120cm shaped single meeting table
 Plateau additionnel pour table de réunion (240x120 cm) multiforme simple
 Superficie añadida para mesa de reuniones (240x120 cm) multiforme individual

MISURA		CODICE		Cristallo Glass / Vitre / Cristal				Pelle Leather / Cuir / Piel			
				R	M	B	W	R	M	B	W
248x120		40098		rosso red rouge rojo	moka coffee café moka	beige beige beige beige	bianco white blanc blanco	rosso red rouge rojo	moka coffee café moka	beige beige beige beige	bianco white blanc blanco
					1.107,00	1.107,00	1.107,00	1.453,00	1.453,00	1.453,00	1.453,00

ELEMENTO

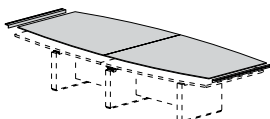

DESCRIZIONE

Piano aggiuntivo per tavolo riunione (cm 300x120) componibile sagomato
 Additional worktop for 300x120cm shaped modular meeting table
 Plateau additionnel pour table de reunion (300x120 cm) à éléments multiforme
 Superficie añadida para mesa de reuniones (300x120 cm) componibile multiforme

MISURA		CODICE		Cristallo Glass / Vitre / Cristal				Pelle Leather / Cuir / Piel			
				R	M	B	W	R	M	B	W
308x120		40102		rosso red rouge rojo	moka coffee café moka	beige beige beige beige	bianco white blanc blanco	rosso red rouge rojo	moka coffee café moka	beige beige beige beige	bianco white blanc blanco
				1.526,00	1.526,00	1.526,00	1.526,00	1.989,00	1.989,00	1.989,00	1.989,00

Elementi aggiuntivi per tavoli riunione
 Additional components for meeting tables
 Éléments additionnels pour tables réunion
 Componentes añadidos para mesas de reuniones

ELEMENTO

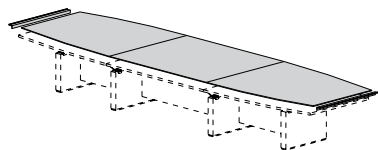

DESCRIZIONE

Piano aggiuntivo per tavolo riunione (cm 450x120) componibile sagomato
 Additional worktop for 450x120cm shaped modular meeting table
 Plateau additionnel pour table de réunion (450x120 cm) à éléments multiforme
 Superficie añadida para mesa de reuniones (450x120 cm) componible multiforme

MISURA	CODICE	Cristallo Glass / Vitre / Cristal				Pelle Leather / Cuir / Piel			
		R rosso red rouge rojo	M moka coffee café moka	B beige beige beige beige	W bianco white blanc blanco	R rosso red rouge rojo	M moka coffee café moka	B beige beige beige beige	W bianco white blanc blanco
458x120	40106	2.201,00	2.201,00	2.201,00	2.201,00	2.943,00	2.943,00	2.943,00	2.943,00

ELEMENTO

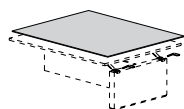

DESCRIZIONE

Piano aggiuntivo per allungo tavolo riunione (cm 150x120) componibile
 Additional worktop for 150x120cm modular meeting table return top
 Plateau additionnel pour retour table de réunion (150x120 cm) à éléments
 Superficie añadida para componente mesa de reuniones (150x120 cm) componible

MISURA	CODICE	Cristallo Glass / Vitre / Cristal				Pelle Leather / Cuir / Piel			
		R rosso red rouge rojo	M moka coffee café moka	B beige beige beige beige	W bianco white blanc blanco	R rosso red rouge rojo	M moka coffee café moka	B beige beige beige beige	W bianco white blanc blanco
150x120	40110	677,00	677,00	677,00	677,00	956,00	956,00	956,00	956,00

ABC

ELEMENTO

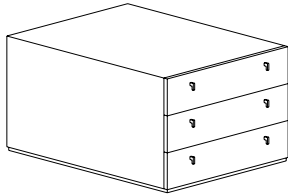

DESCRIZIONE

Cassettiera portante 3 cassetti (viene fornita già assemblata)
 Bearing drawer unit with 3 drawers (supplied already assembled)
 Caisson portant a 3 tiroirs (est fourni déjà assemblé)
 Cajonera portante con 3 cajones (se entrega montada)

		Frontale nobilitato Melamine front / Façade en mélamine / Frontal melamínico			
		WE wengé wengé wengé wengé	RC rovere chiaro light oak chêne clair roble claro		
MISURA	CODICE				
64	40120	572,00	588,00		

ELEMENTO

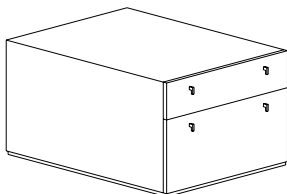

DESCRIZIONE

Cassettiera portante schedario (viene fornita già assemblata)
 Filing bearing drawer unit (supplied already assembled)
 Caisson portant pour dossiers suspendus (est fourni déjà assemblé)
 Cajonera portante archivador (se entrega montada)

		Frontale nobilitato Melamine front / Façade en mélamine / Frontal melamínico			
		WE wengé wengé wengé wengé	RC rovere chiaro light oak chêne clair roble claro		
MISURA	CODICE				
64	40121	509,00	525,00		

ELEMENTO

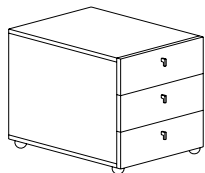

DESCRIZIONE

Cassettiera 3 cassetti (viene fornita già assemblata)
 3 Drawer unit (supplied already assembled)
 Caisson a 3 tiroirs (est fourni déjà assemblé)
 Cajonera con 3 cajones (se entrega montada)

CASSETTI PVC
 PVC D.
 T. EN PVC
 C. DE PVC

MISURA CODICE

42

40125

333,00

345,00

CASSETTI METALLO
 METAL D.
 T. EN MÉTAL
 C. DE METAL

42

40126

444,00

458,00

Frontale nobilitato
 Melamine front / Façade en mélamine / Frontal melamínico

WE
 wengé
 wengé
 wengé
 wengé

RC
 rovere chiaro
 light oak
 chêne clair
 roble claro

ELEMENTO

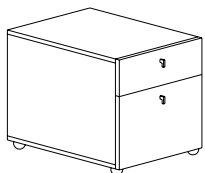

DESCRIZIONE

Cassettiera schedario (viene fornita già assemblata)
 Filing drawer unit (supplied already assembled)
 Caisson pour dossiers suspendus (est fourni déjà assemblé)
 Cajonera archivador (se entrega montada)

CASSETTI METALLO
 METAL D.
 T. EN MÉTAL
 C. DE METAL

MISURA CODICE

42

40127

386,00

398,00

Frontale nobilitato
 Melamine front / Façade en mélamine / Frontal melamínico

WE
 wengé
 wengé
 wengé
 wengé

RC
 rovere chiaro
 light oak
 chêne clair
 roble claro

ELEMENTO

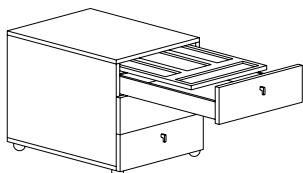

DESCRIZIONE

Cassettiera 3 cassetti con cassetto cancelleria (viene fornita già assemblata)
 3 Drawer unit with stationary tray (supplied already assembled)
 Caisson a 3 tiroirs avec tirette porte-plumier (est fourni déjà assemblé)
 Cajonera con 3 cajones con cajón plumier (se entrega montada)

		Frontale nobilitato Melamine front / Façade en mélamine / Frontal melamínico			
		WE wengé wengé wengé wengé	RC rovere chiaro light oak chêne clair roble claro		
MISURA	CODICE				
CASSETTI PVC PVC D. T. EN PVC C. DE PVC	42 40128	363,00	373,00		
CASSETTI METALLO METAL D. T. EN MÉTAL C. DE METAL	42 40129	474,00	486,00		

ELEMENTO

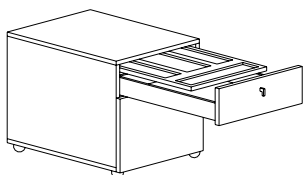

DESCRIZIONE

Cassettiera schedario con cassetto cancelleria
 (viene fornita già assemblata)
 Filing drawer unit with stationary tray
 (supplied already assembled)
 Caisson pour dossiers suspendus avec tirette porte-plumier
 (est fourni déjà assemblé)
 Cajonera archivador con cajón plumier
 (se entrega montada)

		Frontale nobilitato Melamine front / Façade en mélamine / Frontal melamínico			
		WE wengé wengé wengé wengé	RC rovere chiaro light oak chêne clair roble claro		
MISURA	CODICE				
CASSETTI METALLO METAL D. T. EN MÉTAL C. DE METAL	42 40130	415,00	428,00		

Cassettiere su ruote
 Drawer units on castors
 Caissons sur roulettes
 Cajoneras con ruedas

ELEMENTO

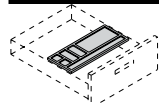

DESCRIZIONE

Vaschetta portacancelleria per cassetto
 Stationary tray for drawer
 Porte-plumier pour tiroir
 Bandeja plumier para cajón

		Plastica Plastic / Plastique / Plástico			
		C accessori accessories accessoires accesorios			
MISURA	CODICE				
PER CASSETTO PVC FOR PVC D. POUR T. EN PVC POR C. DE PVC	13776	14,00			
PER CASSETTO METALLO FOR METAL D. POUR T. EN MÉTAL POR C. DE METAL	13777	16,00			

ELEMENTO

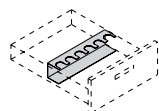

DESCRIZIONE

Portatimbri per cassetto
 Stamp holder for drawer
 Porte-tampons pour tiroir
 Porta-sellos para cajón

		Metallo Metal / Métal / Metal			
		C accessori accessories accessoires accesorios			
MISURA	CODICE				
PER CASSETTO METALLO FOR METAL D. POUR T. EN MÉTAL POR C. DE METAL	42 13778	28,00			

ABC

Cassettiere su ruote
 Drawer units on castors
 Caissons sur roulettes
 Cajoneras con ruedas

ELEMENTO

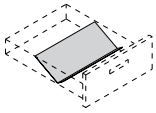

DESCRIZIONE

Divisorio inclinato A4 per cassetto
 A4 inclined divider for drawer
 Separation inclinée A4 pour tiroir
 Separador inclinado A4 para cajón

		Metallo Metal / Métal / Metal			
		C accessori accessoires accessoires accesorios			
MISURA	CODICE				
PER CASSETTO METALLO FOR METAL D. POUR T. EN MÉTAL POR C. DE METAL	13779		28,00		

ELEMENTO

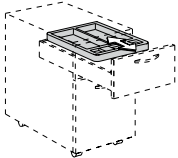

DESCRIZIONE

Cassettino H 5 portacancelleria (inseribile su tutte le cassettiere)
 5 H stationary tray (it can be inserted into all drawer units)
 Tirette porte-plumier H 5 (que l'on peut introduire dans tous les caissons)
 Cajón plumier de 5 H (se puede colocar en todas las cajoneras)

		Plastica Plastic / Plastique / Plástico			
		C accessori accessoires accessoires accesorios			
MISURA	CODICE				
38x50	13780		40,00		

ELEMENTO

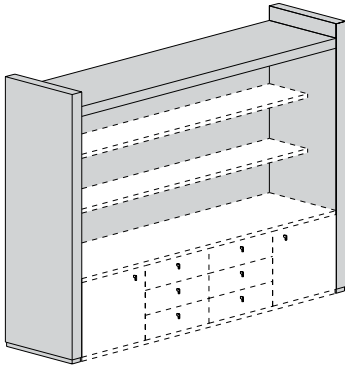

DESCRIZIONE

Portale per boiserie (ordinare serventi pag. 44)
Boiserie frame (order pedestals page 44)
Structure boiserie (commander dessertes page 44)
Estructura boiserie (pedir pedestales página 44)

DEVE ESSERE FISSATA A MURO PER
MAGGIORE STABILITA'
MUST BE FIXED TO THE WALL FOR
STABILITY
FIXEE AU MUR POUR PLUS DE
STABILITE
DEBE SER FIJADO A LA PARED

MISURA	CODICE	Struttura Structure / Corps / Estructura		
215	40160	WE wengé wengé wenge wengé		
		2.466,00		

ELEMENTO

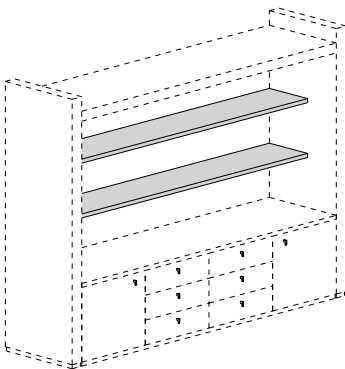

DESCRIZIONE

Coppia mensole
Pair of shelves
Paire de tablettes
Par de estantes

MISURA	CODICE	Nobilitato Melamine / Mé laminé / Melamínico			Cristallo Glass / Vitre / Cristal				
		WE wengé wengé wengé	RC rovere chiaro light oak chêne clair roble claro		W bianco white blanc blanco	R rosso red rouge rojo	M moka coffee cafe moka	B beige beige beige beige	S satinato satiné satinado
200x30	40161	412,00	427,00		762,00	762,00	762,00	762,00	947,00

ELEMENTO

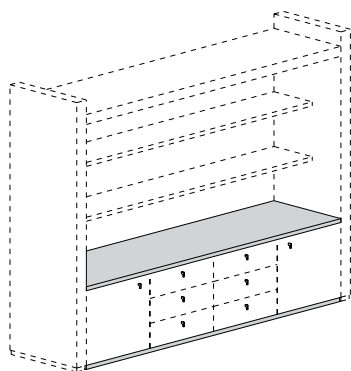

DESCRIZIONE

Top di finitura (Sp 2.8) Completo di basamento in nobilitato alluminio (Sp 1.8)
2.8 Thick top with 1.8 Thick melamine base aluminium finish
Top épaisseur 2,8 muni de base en melamine coloris aluminium épaisseur 1,8
Superficie de 2,8 de grosor con base de melamina color aluminio de 1,8 de grosor

		Nobilitato Melamine / Mélaminé / Melamínico			
		WE wengé wengé wengé wengé	RC rovere chiaro light oak chêne clair roble claro		
MISURA	CODICE				
200x50	40150	203,00	209,00		

Esplicativo componibilità serventi
Pedestals modularity
Details de composition pour dessertes
Explicativo para componentes de pedestales

DESCRIZIONE

I serventi del modello Abc sono realizzati con dei contenitori (forniti già montati) da assemblare tra loro sul cantiere. Tale peculiarità consente di poter assemblare secondo le proprie esigenze i contenitori che compongono il servente stesso. Inoltre, si ha la possibilità di poter aprire i contenitori sia verso l'interno che verso l'esterno.

The pedestals from the ABC range are made up of containers (supplied already assembled) to be fitted together on site. This peculiarity allows for assembly of the storage units that make up the pedestal itself to be carried out according to personal requirements. Furthermore, the storage units can be opened inwards or outwards. Les dessertes du modèle Abc sont réalisées avec des armoires (fournies déjà montées) à assembler entre eux sur place. On a ainsi la possibilité d'assembler selon sa propre exigence les armoires qui composeront la desserte. De plus, les portes peuvent s'ouvrir vers l'intérieur ou vers l'extérieur.

Los pedestales del modelo Abc se realizan con muebles (se entregan ya montados) componibles entre ellos in situ. Esta peculiaridad permite poder ensamblar según las propias exigencias los muebles que forman el pedestal mismo. Además, se pueden abrir los muebles sea hacia dentro que hacia fuera.

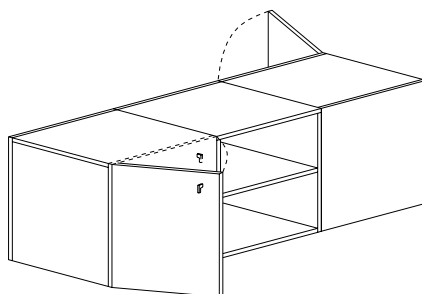
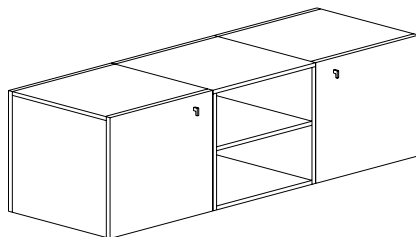

ABC

Esplicativo componibilità serventi
Pedestals modularity
Details de composition pour dessertes
Explicativo para componentes de pedestales

ELEMENTO

DESCRIZIONE

Piano consolle completo di 2 basamenti in nobilitato alluminio
Console worktop complete with two melamine bases in an aluminium finish
Plateau console muni de deux bases en melamine coloris aluminium
Superficie consola con dos bases de melamina color aluminio

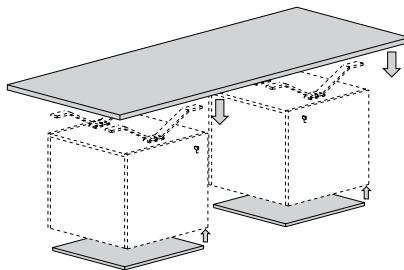

DESCRIZIONE

Piano consolle completo di basamento in nobilitato alluminio
Console worktop complete with a melamine base in an aluminium finish
Plateau console muni de base en melamine coloris aluminium
Superficie consola con base de melamina color aluminio

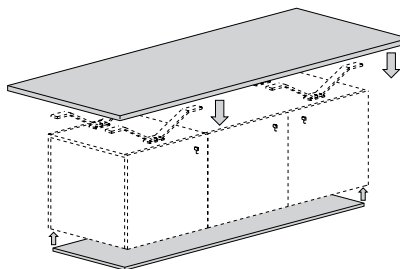

Esplicativo componibilità serventi
Pedestals modularity
Details de composition pour dessertes
Explicativo para componentes de pedestales

ELEMENTO

DESCRIZIONE

Mobile con top di finitura completo di basamento in nobilitato alluminio
Storage unit with finishing top complete with a melamine base in an aluminium finish
Element avec top de finition muni de base en melamine coloris aluminium
Mueble con superficie de acabado con base de melamina color aluminio

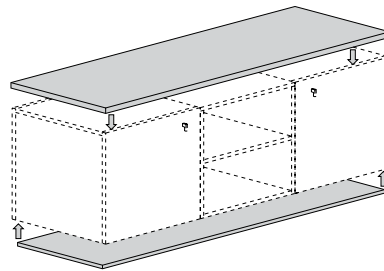

DESCRIZIONE

Mobile con top di finitura completo di basamento in estruso di alluminio
Storage unit with finishing top complete with a melamine base in extruded aluminium
Element avec top de finition muni de base en extrude d'aluminium
Mueble con superficie de acabado con base de extrusionado de aluminio

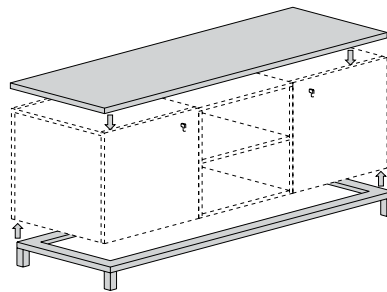

ELEMENTO

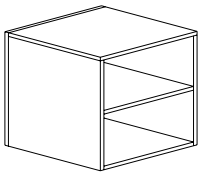

DESCRIZIONE

Servente (viene fornito già assemblato) 1 ripiano
 Pedestal (it is supplied already assembled) 1 shelf
 Desserte (est fournie déjà assemblée) 1 tablette
 Pedestal (se entrega montado) 1 estante

		Nobilitato Melamine / Méla miné / Melamínico			
		WE wengé wengé wenge wengé			
MISURA	CODICE				
50	40135		182,00		

ELEMENTO

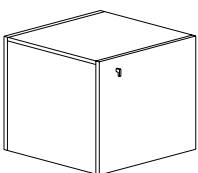

DESCRIZIONE

Servente (viene fornito già assemblato) 1 ripiano - anta 1 kit
 Pedestal (it is supplied already assembled) 1 shelf - 1 kit for door
 Desserte (est fournie déjà assemblée) 1 tablette - 1 kit pour la porte
 Pedestal (se entrega montado) 1 estante - 1 kit para la puerta

		Frontale nobilitato Melamine front / Façade en méla miné / Frontal melamínico			
		WE wengé wengé wenge wengé	RC rovere chiaro light oak chêne clair roble claro		
MISURA	CODICE				
50	DX40136		258,00	267,00	
	SX40137				

ELEMENTO

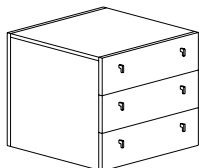

DESCRIZIONE

Servente (viene fornito già assemblato)
Pedestal (it is supplied already assembled)
Desserte (est fournie déjà assemblée)
Pedestal (se entrega montado)

		Frontale nobilitato Melamine front / Façade en mélamine / Frontal melamínico			
		WE wengé wengé wengé wengé	RC rovere chiaro light oak chêne clair roble claro		
MISURA	CODICE				
50	40138	316,00	325,00		

ELEMENTO

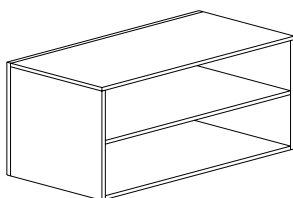

DESCRIZIONE

Servente (viene fornito già assemblato) 1 ripiano
Pedestal (it is supplied already assembled) 1 shelf
Desserte (est fournie déjà assemblée) 1 tablette
Pedestal (se entrega montado) 1 estante

		Struttura nobilitato Melamine structure / Corps en mélamine / Estructura melamínica			
		WE wengé wengé wengé wengé			
MISURA	CODICE				
100	40142	264,00			

Serventi
Pedestals
Dessertes
Pedestales

ELEMENTO

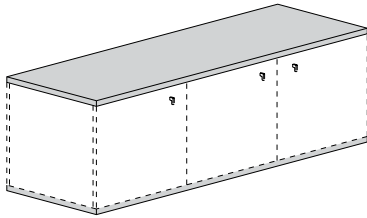

DESCRIZIONE

Top di finitura (Sp 2.8) completo di basamento in nobilitato alluminio (Sp 1.8) per mobile retro scrivania
 2.8 thick top with 1.8 thick melamine base aluminium finish for rear desk element
 Top épaisseur 2,8 muni de base en melamine coloris aluminium épaisseur 1,8 pour meuble arriere-bureau
 Superficie de 2,8 de grosor con base de melamina color aluminio de 1,8 de grosor para mueble retro scrivania

		Top Nobilitato Melamine top / Top en mélamine / Superficie melamínica			
MISURA	CODICE	WE wengé wengé wenge wengé	RC rovere chiaro light oak chêne clair roble claro		
100x50	40148		134,00	137,00	
150x50	40149		170,00	175,00	
200x50	40150		203,00	209,00	

ELEMENTO

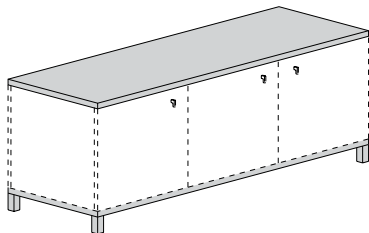

DESCRIZIONE

Top di finitura (Sp 2.8) completo di basamento in estruso di alluminio (H14.5) per mobile retro scrivania
 2.8 thick top with 14.5 height extruded aluminium base for rear desk element
 Top épaisseur 2,8 muni de base en extrude d'aluminium hauteur 14,5 pour meuble arriere-bureau
 Superficie de 2,8 de grosor con base de extrusionado de aluminio de 14,5 de altura para mueble retro scrivania

		Top Nobilitato Melamine top / Top en mélamine / Superficie melamínica			
MISURA	CODICE	WE wengé we we we	RC rovere chiaro		
100x50	40154				
150x50	40155				
200x50	40156				

ARTICOLO FUORI PRODUZIONE
DISCONTINUED ITEM
ARTICLE SORTIE DE PRODUCTION

