

Must

Informazioni

Information
Informations
Información

3 **Caratteristiche tecniche**

4 Technical details
5 Caractéristiques techniques
6 Características técnicas

7 **Peso, volume, colli**

Weight, volumes, packages
Poids, volume, colis
Peso, volumen, bultos

9 **Abbinamenti colore e come ordinare**

Colour matching and how to order
Association coloris et comment passer la commande
Combinación de colores y modo de hacer pedidos

Scrivanie e tavoli riunione

Desks and meeting tables
Bureaux et tables reunion
Escritorios y mesas de reuniones

12 **Scrivanie**

Desks
Bureaux
Escritorios

18 **Complanari**

Return tops
Retours
Extensiones

21 **Modesty panels**

Modesty panels
Voiles de fond
Faldones

22 **Tavoli riunione**

Meeting tables
Tables réunion
Mesas de reuniones

Zona attesa e boiserie

Waiting area and boiserie
Zone d'accueil et boiserie
Zona de espera y boiserie

30 **Zona di attesa**

Waiting area
Zone d'accueil
Zona de espera

31 **Boiserie**

Boiserie
Boiserie
Boiserie

Cassettiere e serventi

Drawer units and pedestals
Caissons et dessertes
Cajoneras y pedestales

35 **Cassettiere e serventi**

Drawer units and pedestals
Caissons et dessertes
Cajoneras y pedestales



Caratteristiche fisico-meccaniche dei pannelli in nobilitato melaminico

Emissione di formaldeide: E1

Spessori: cm 1.2 – 1.8 – 2.8

Densità: kg 660 (+ -3%) mc (DIN 68763/81)

Scrivanie/Tavoli riunione/Complanari

Tipologia vetro: Vetro temperato spessore cm 1.2.

Colori: **S** Satinato - **KV** Nero - **VV** Curry (RAL 1027)

Tipologia legno: MDF spessore cm 2.8 impiallacciati in essenza di legno e verniciati con finitura a poro aperto ed antiriflesso.

Bordati su 4 lati con bordo legno stondato antiurto.

Colori: **WE** Wengé

Gambe metallo

Estruso di alluminio con sezione triangolare, anodizzato brillantato.

Calotte superiori ed inferiori in pressofusione di alluminio con finitura cromo.

Piastre di attacco al piano in pressofusione di alluminio con finitura eco-cromo.

Piedi livellabili in ABS.

Colori: **K** Cromato

Modesty Panels

Agglomerato ligneo in classe E1.

Spessore cm 1.8 impiallacciati in essenza di legno e verniciati con finitura a poro aperto ed antiriflesso.

Bordati su 4 lati con bordo legno stondato antiurto.

Colori: **WO** Bianco opaco - **WE** Wengé

Zona di attesa

Agglomerato ligneo di pioppo in classe E1 spessore cm 4. Impiallacciati in essenza di legno e verniciati con finitura a poro aperto ed antiriflesso.

Bordati su 4 lati con bordo legno stondato antiurto.

Colori: **WO** Bianco opaco - **WE** Wengé

Cassettiere con cassetti legno/Serventi

Struttura e frontali in agglomerato ligneo in classe E1.

Spessore cm 1.8 - 2.5 impiallacciati in essenza di legno e verniciati con finitura a poro aperto ed antiriflesso.

Bordati su 4 lati con bordo legno stondato antiurto.

Le cassette sono dotate di 4 ruote in plastica pigmentata (ad alta durata), di serratura con chiusura simultanea dei cassetti e guide ammortizzate.

I serventi e le cassette portanti sono dotati di piedini livellabili in ABS.

Tutte le tipologie ad ante sono complete di serratura e cerniere con apertura 105° con fermo ammortizzato.

Maniglie in pressofusione di zama con finitura cromata.

Colori: **WO** Bianco opaco - **WE** Wengé

Cassettiere con cassetti metallo

Struttura e frontali in agglomerato ligneo in classe E1. Spessore cm 1.8 impiallacciati in essenza di legno e verniciati con finitura a poro aperto ed antiriflesso.

Bordati su 4 lati con bordo legno stondato antiurto.

Le cassette sono dotate di 4 ruote in plastica pigmentata (ad alta durata), di serratura con chiusura simultanea dei cassetti.

Le cassette portanti sono dotate di piedini livellabili in ABS.

Maniglie in pressofusione di zama con finitura cromata.

Colori: **WO** Bianco opaco - **WE** Wengé

Boiserie

Moduli Boiserie

Agglomerato ligneo in classe E1.

Spessore cm 1.8 impiallacciati in essenza di legno e verniciati con finitura a poro aperto ed antiriflesso.

Bordati su 4 lati con bordo legno stondato antiurto.

Dotati di piedini di livellamento e attacchi pensili a scomparsa.

Colori: **WO** Bianco opaco - **WE** Wengé

Mensole

Tipologia vetro: vetro temperato spessore cm 1.2.

Colori: **S** Satinato - **KV** Nero - **VV** Curry (RAL 1027)

Tipologia legno: MDF spessore cm 4 impiallacciate in essenza di legno e verniciate con finitura a poro aperto ed antiriflesso.

Bordate su 4 lati con bordo legno stondato antiurto.

Colori: **WO** Bianco opaco - **WE** Wengé

Mobile pensile

Agglomerato ligneo in classe E1.

Spessore cm 1.8 impiallacciati in essenza di legno e verniciati con finitura a poro aperto ed antiriflesso.

Completo di serratura.

Colori: **WO** Bianco opaco - **WE** Wengé

Physical-mechanical characteristics of the melamine panels

Level of emission of formaldehyde: E1

Thickness: 1.2 - 1.8 - 2.8cm.

Density: 660 kg (± 3%) cbm. (DIN 68763/81)

Desks/Meeting tables/Return tops

Glass type: tempered glass, 1.2cm thick.

Colours: **S** Satined - **KV** Black - **VV** Curry (RAL 1027)

Wood type: 2.8cm thick MDF panel with wood veneer, painted with an open pore finish, anti-glare.

Rounded shockproof wooden edging on all 4 sides.

Colours: **WE** Wengé

Metal legs

Triangular section made from extruded aluminium in a shiny anodized finish.

Upper and lower crown made from die cast aluminium with a chrome-plated finish.

Plates for fixing to the top made of die cast aluminium with a chrome-plated finish.

Adjustable feet in ABS.

Colours: **K** Chrome-plated

Modesty panels

Wood agglomerate class E1.

1.8cm thick, wood veneer painted with an open pore finish, anti-glare.

Rounded shockproof wooden edging on all 4 sides.

Colours: **WO** Matt white - **WE** Wengé

Waiting area

Poplar wood agglomerate class E1, 4cm thick.

Wood veneer painted with an open pore finish, anti-glare.

Rounded shockproof wooden edging on all 4 sides.

Colours: **WO** Matt white - **WE** Wengé

Drawer units with wooden drawers/Pedestals

Structure and fronts made from wood agglomerate class E1.

1.8 - 2.5cm thick, wood veneer painted with an open pore finish, anti-glare.

Rounded shockproof wooden edging on all 4 sides.

The drawer units are fitted with 4 pigmented plastic castors (long lasting), lock with central locking of all drawers and shock absorbent glides.

The pedestals and the bearing drawer units are equipped with adjustable feet in ABS.

All units with doors are equipped with lock and 105° hinges with a shock absorbent closing system.

Handles made from a die cast zama alloy with a chrome-plated finish.

Colours: **WO** Matt white - **WE** Wengé

Drawer units with metal drawers

Structure and fronts made from wood agglomerate class E1. 1.8 thick, wood veneer painted with an open pore finish, anti-glare.

Rounded shockproof wooden edging on all 4 sides. The drawer units are fitted with 4 pigmented plastic castors (long lasting), lock with central locking of all drawers.

The bearing drawer units are equipped with adjustable feet in ABS.

Handles made from a die cast zama alloy with a chrome-plated finish.

Colours: **WO** Matt white - **WE** Wengé

Boiserie

Boiserie panels

Wood agglomerate class E1.

1.8 cm thick, wood veneer painted with an open pore finish, anti-glare.

Rounded shockproof wooden edging on all 4 sides. Equipped with adjustable legs and wall unit hidden fittings.

Colours: **WO** Matt white - **WE** Wengé

Shelves

Glass type: tempered glass, 1.2cm thick.

Colours: **S** Satined - **KV** Black - **VV** Curry (RAL 1027)

Wood type: 4cm thick MDF veneered panel, painted with an open pore finish, anti-glare.

Rounded shockproof wooden edging on all 4 sides.

Colours: **WO** Matt white - **WE** Wengé

Wall unit

Wood agglomerate class E1.

1.8 cm thick, wood veneer painted with an open pore finish, anti-glare.

With lock.

Colours: **WO** Matt white - **WE** Wengé

Caractéristiques physico-mécaniques des panneaux en mélamine

Emission de formaldéhyde: E1

Épaisseurs: 1,2 - 1,8 - 2,8 cm.

Densité: 660 kg (± 3%) m³ (DIN 68763/81).

Bureaux/Tables réunion/Retours

Type de verre: Verre trempé épaisseur 1,2 cm.

Coloris: **S** Satiné - **KV** Noir - **VV** Curry (RAL 1027)

Type de bois: MDF épaisseur 2,8 cm, plaqué en bois et verni à pores ouverts, antireflet.

Chant arrondi antichoc en bois sur tous les côtés.

Coloris: **WE** Wengé

Pieds en métal

Extrudé d'aluminium avec section triangulaire, anodisé brillant.

Calottes supérieures et inférieures en moulage sous pression d'aluminium avec finition chromé.

Plaques pour raccord au plan en moulage sous pression d'aluminium avec finition chromé.

Pieds de nivellement en ABS.

Coloris: **K** Chromé

Voiles de fond

Aggloméré en bois classe E1.

Épaisseur 1,8 cm, plaqué en bois, verni à pores ouverts, antireflet.

Chant arrondi antichoc en bois sur tous les côtés.

Coloris: **WO** Blanc opaque - **WE** Wengé

Zone d'accueil

Aggloméré en bois de peuplier classe E1, épaisseur 4 cm.

Plaqué en bois, verni à pores ouverts, antireflet.

Chant arrondi antichoc en bois sur tous les côtés.

Coloris: **WO** Blanc opaque - **WE** Wengé

Caissons avec tiroirs en bois et dessertes

Corps et façades en aggloméré en bois classe E1.

Épaisseur: 1,8 - 2,5 cm, plaqués en bois, vernis à pores ouverts, antireflet.

Chant arrondi antichoc en bois sur tous les côtés.

Les caissons sont dotés de 4 roulettes en plastique pigmenté (usage intensif), de serrure centralisée des tiroirs et de glissières amorties.

Les dessertes et les caissons porteurs sont dotés de pieds de nivellement en ABS.

Tous les meubles avec portes sont dotés de serrure, de charnières avec ouverture 105° et amortisseurs de fermeture.

Poignées en moulage sous pression de zamak avec finition chromé.

Coloris: **WO** Blanc opaque - **WE** Wengé

Caissons avec tiroirs en métal

Corps et façades en aggloméré en bois classe E1.

Épaisseur: 1,8 cm, plaqués en bois, vernis à pores ouverts, antireflet.

Chant arrondi antichoc en bois sur tous les côtés.

Les caissons sont dotés de 4 roulettes en plastique pigmenté (usage intensif) et de serrure centralisée des tiroirs.

Les caissons porteurs sont dotés de pieds de nivellement en ABS.

Poignées en moulage sous pression de zamak avec finition chromé.

Coloris: **WO** Blanc opaque - **WE** Wengé

Boiserie

Modules de boiserie

Aggloméré en bois classe E1.

Épaisseur: 1,8 cm, plaqué en bois, verni à pores ouverts, antireflet.

Chant arrondi antichoc en bois sur tous les côtés.

Dotés de pieds de nivellement et de fixations pour éléments hauts dissimulées.

Coloris: **WO** Blanc opaque - **WE** Wengé

Étagères

Type de verre: Verre trempé épaisseur 1,2 cm.

Coloris: **S** Satiné - **KV** Noir - **VV** Curry (RAL 1027)

Type de bois: Panneau MDF, épaisseur 4 cm, plaqué en bois et verni à pores ouverts, antireflet.

Chant arrondi antichoc en bois sur tous les côtés.

Coloris: **WO** Blanc opaque - **WE** Wengé

Élément haut

Aggloméré en bois classe E1.

Épaisseur: 1,8 cm, plaqué en bois, verni à pores ouverts, antireflet.

Doté de serrure.

Coloris: **WO** Blanc opaque - **WE** Wengé

Características físico-mecánicas de los paneles melamínicos

Emisión de formaldehído: E1

Grosos: 1,2 - 1,8 - 2,8 cm.

Densidad: 660 Kg. (± 3%) m3 (DIN 68763/81).

Escritorios, mesas de reuniones y extensiones

Tipo de cristal: cristal templado de 1,2 cm. de grosor.

Colores: **S** Satinado - **KV** Negro - **VV** Curry (RAL 1027)

Tipo de madera: MDF de 2,8 cm. de grosor, enchapado de madera y pintado con poro abierto, antirreflejo.

Con borde de madera curvo a prueba de golpes en todos los lados.

Colores: **WE** Wengé

Patas metálicas

Extrusionado de aluminio con sección triangular, anodizado brillantado.

Casquetes superiores e inferiores de aluminio de

vaciado a presión en acabado de cromado.

Placas para unir a la superficie en aluminio de vaciado a presión en acabado e cromado.

Patas regulables de ABS.

Colores: **K** Cromado

Faldones

Conglomerado de madera de clase E1.

1,8 cm. de grosor, enchapado de madera y pintado con poro abierto, antirreflejo.

Con borde de madera curvo a prueba de golpes en todos los lados.

Colores: **WO** Blanco mate - **WE** Wengé

Zona de espera

Conglomerado de madera de álamo de clase E1.

1,8 cm. de grosor, enchapado de madera y pintado con poro abierto, antirreflejo.

Con borde de madera curvo a prueba de golpes en todos los lados.

Colores: **WO** Blanco mate - **WE** Wengé

Cajoneras con cajones de madera y pedestales

Estructura y frontales de conglomerado de madera de clase E1.

Grosor de 1,8 - 2,5 cm., enchapados de madera y pintados con poro abierto, antirreflejo.

Con borde de madera curvo a prueba de golpes en todos los lados.

Las cajoneras son dotadas de 4 ruedas de plástico pigmentado (de larga duración), de cerradura de sierra simultáneo de los cajones y guías amortizadotas.

Los pedestales y las cajoneras portantes son dotados de patas regulables de ABS.

Todos los muebles con puertas disponen de cerradura y bisagras amortizadas con apertura 105°.

Tiradores de vaciado a presión de zama de acabado cromado.

Colores: **WO** Blanco mate - **WE** Wengé

Cajoneras con cajones de metal

Estructura y frontales de conglomerado de madera de clase E1.

Grosor de 1,8 cm., enchapados de madera y pintados con poro abierto, antirreflejo.

Con borde de madera curvo a prueba de golpes en todos los lados.

Las cajoneras son dotadas de 4 ruedas de plástico pigmentado (de larga duración) y de cerradura de sierra simultáneo de los cajones.

Las cajoneras portantes son dotadas de patas regulables de ABS.

Tiradores de vaciado a presión de zama de acabado cromado.

Colores: **WO** Blanco mate - **WE** Wengé

Boiserie

Módulos boiserie:

Conglomerado de madera de clase E1.

1,8 cm. de grosor, enchapado de madera y pintado con poro abierto, antirreflejo.

Con borde de madera curvo a prueba de golpes en todos los lados.

Dotados de patas regulables y ganchos para módulos altos.

Colores: **WO** Blanco mate - **WE** Wengé

Estantes

Tipo de cristal: cristal templado de 1,2 cm. de grosor.

Colores: **S** Satinado - **KV** Negro - **VV** Curry (RAL 1027)

Tipo de madera: Panel de MDF de 4 cm. de grosor, enchapado de madera y pintado con poro abierto, antirreflejo.

Con borde de madera curvo a prueba de golpes en todos los lados.

Colores: **WO** Blanco mate - **WE** Wengé

Módulo alto

Conglomerado de madera de clase E1.

1,8 cm. de grosor, enchapado de madera y pintado con poro abierto, antirreflejo.

Con cerradura.

Colores: **WO** Blanco mate - **WE** Wengé

Peso, volume e colli
 Weight, volume and packages
 Poids, volume et colis
 Peso, volumen y bultos

Codice Code Code Código	Peso Weight Poids Peso kg	Volume Volume Volumen m³	Colli Packages Colis Bultos n°	Codice Code Code Código	Peso Weight Poids Peso kg	Volume Volume Volumen m³	Colli Packages Colis Bultos n°	Codice Code Code Código	Peso Weight Poids Peso kg	Volume Volume Volumen m³	Colli Packages Colis Bultos n°
3843	2	0,01	1	17861	17	0,07	2	17908	35	0,27	3
13457	3	0,02	1	17862	17	0,07	2	17909	30	0,18	4
13459	2	0,01	1	17863	17	0,07	2	17910	35	0,27	4
13780	1	0,01	1	17870	82	0,16	5	17911	30	0,18	5
13891	0,8	0,01	1	17872	82	0,16	5	17914	55	0,52	1
13892	0,1	0,01	1	17875	178	0,32	8	17915	55	0,52	2
13893	0,1	0,01	1	17876	254	0,44	9	17916	55	0,52	2
13894	0,1	0,01	1	17880	158	0,32	8	17925	38	0,092	5
13897	10	0,08	1	17880WE	78	0,3	10	17926	38	0,092	4
13898	0,3	0,01	1	17881	188	0,35	8	17936	65	0,162	6
17800	82	0,18	5	17881WE	88	0,33	10	17945	83	0,22	7
17800WE	42	0,17	5	17885	188	0,28	8	17946	83	0,22	6
17801	97	0,19	5	17886	218	0,36	8	17948	85	0,23	8
17801WE	47	0,18	5	17890	370	0,65	14	17949	85	0,23	8
17803	79	0,18	6	17892	294	0,48	11	17961	6	0,02	2
17803WE	39	0,17	6	17894	1.080	2,28	36	17963	12	0,04	3
17804	94	0,19	6	17895	76	0,14	3	17965	18	0,06	3
17804WE	44	0,18	6	17895WE	36	0,13	4	17970	10	0,04	3
17810	102	0,19	5	17896	91	0,15	3	17971	18	0,06	5
17812	99	0,19	6	17896WE	41	0,13	4	17972	24	0,08	3
17814	152	0,3	8	17897	76	0,12	3	19630	24	0,07	2
17815	152	0,3	8	17898	91	0,16	3	19635	14	0,05	2
17820	117	0,22	5	17899	96	0,15	3	19675	1	0,02	1
17822	114	0,22	6	17900	25	0,15	1	43650	5	0,015	1
17830	97	0,2	5	17901	50	0,3	2	43651	4	0,015	1
17832	94	0,2	6	17903	10	0,05	4	43660	5,5	0,05	1
17835WE	17	0,05	2	17903WE	10	0,05	2	43680	0,01	0,001	1
17840	57	0,14	4	17904	20	0,1	2	43681	0,01	0,001	1
17841	87	0,16	5	17904WE	20	0,1	1				
17843	87	0,16	3	17905	40	0,2	4				
17850	60	0,14	5	17905WE	40	0,2	2				
17860	14	0,05	2	17907	50	0,36	2				

MUST

Abbinamenti colore e come ordinare
Colour matching and how to order
Association coloris et comment passer la commande
Combinación de colores y modo de hacer pedidos

- 10 **Scrivanie, tavoli riunione, complanari**
Desks, meeting tables, return tops
Bureaux, tables réunion, retours
Escritorios, mesas de reuniones, extensiones
- 11 **Cassettiere e serventi**
Drawer units and pedestals
Caissons et dessertes
Cajoneras y pedestales

Scrivanie, tavoli riunione, complanari

Desks, meeting tables, return tops

Bureaux, tables réunion, retours

Escritorios, mesas de reuniones, extensiones

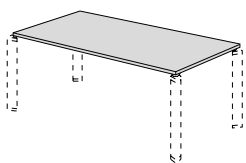

Piano legno

Wooden worktop

Plateau en bois

Superficie de madera

WE Wengé
Wengé
Wengé
Wengé

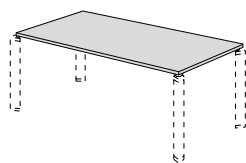

Piano vetro

Glass worktop

Plateau en verre

Superficie de cristal

S Satinato
Satiné
Satiné
Satinado

KV Nero
Black
Noir
Negro

WV Curry (Ral 1027)
Curry
Curry
Curry

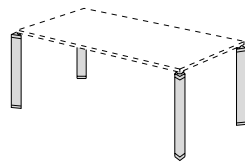

Struttura metallica

Metallic structure

Structure en métal

Estructura de metal

K Cromato
Chrome-plated
Chromé
Cromado

Per una corretta compilazione dell'ordine bisogna indicare:

- colore piano
- codice prodotto
- colore struttura

Esempio:

Scrivania rettangolare 180x100 con piano in vetro nero, struttura in metallo cromato

- Sigla colore piano **KV**
- Codice prodotto **17800**
- Sigla struttura **K**

Compilation of the order must indicate:

- worktop colour
- product code
- structure colour

Example:

180x100 rectangular desk with black glass worktop, chrome-plated metallic structure

- Worktop colour **KV**
- Code **17800**
- Structure **K**

Pour rédiger la commande il faut indiquer:

- coloris plateau
- code produit
- coloris structure

Exemple:

Bureau rectangulaire 180x100 avec plateau en verre noir, structure en métal chromé

- Coloris plateau **KV**
- Code **17800**
- Structure **K**

Para rellenar el impreso del pedido hay que indicar:

- color de la superficie
- código del producto
- color de la estructura

Ejemplo:

Escritorio rectangular 180x100 con superficie de cristal negro, estructura de metal cromado

- Color superficie **KV**
- Código **17800**
- Estructura **K**

Cassettiere e serventi

Drawer units and pedestals

Caissons et dessertes

Cajoneras y pedestales

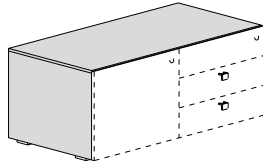
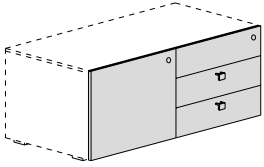

Frontale

Front
Façade
Frontal

WE Wengé
Wengé
Wengé
Wengé

WO Bianco Opaco
Matt White
Blanc Opaque
Blanco Mate

Struttura

Structure
Corps
Estructura

WE Wengé
Wengé
Wengé
Wengé

WO Bianco Opaco
Matt White
Blanc Opaque
Blanco Mate

Per una corretta compilazione dell'ordine bisogna indicare:
- colore frontale/struttura
- codice prodotto

Esempio:
Servente a 2 ante 120x60 con frontale e struttura in wengé

- Sigla colore frontale/
struttura **WE**
- Codice prodotto **17914**

Compilation of the order must indicate:
- front/structure colour
- product code

Example:
120x60cm pedestal with 2 doors, wengé front and structure

- Front/structure colour **WE**
- Code **17914**

Pour rédiger la commande il faut indiquer:
- coloris façade/corps
- code produit

Exemple:
Desserte 120x60 cm avec 2 portes, façade et corps en wengé

- Coloris façade/corps **WE**
- Code **17914**

Para rellenar el impreso del pedido hay que indicar:
- color frontal/estructura
- código del producto

Ejemplo:
Pedestal 120x60 cm. con 2 puertas, frontal y estructura en wengé

- Color frontal/estructura **WE**
- Código **17914**

MUST

ELEMENTO



DESCRIZIONE

Scrivania con gambe

Desk with legs
 Bureau avec pieds
 Escritorio con patas

		Piano impiallacciato Veneered worktop / Plateau plaqué / Superficie enchapada			
		WE wengé wengé wengé wengé			
MISURA	CODICE				
180x100	17800	1.914,00			
210x100	17801	2.048,00			

ELEMENTO

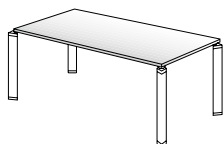

DESCRIZIONE

Scrivania con gambe

Desk with legs
 Bureau avec pieds
 Escritorio con patas

		Piano vetro Glass worktop / Plateau en verre / Superficie de cristal			
		S satinato satinéd satiné satinado	KV nero black noir negro	VV curry (ral 1027) curry curry curry	
MISURA	CODICE				
180x100	17800	1.748,00	1.863,00	1.863,00	
210x100	17801	1.849,00	1.984,00	1.984,00	

ELEMENTO

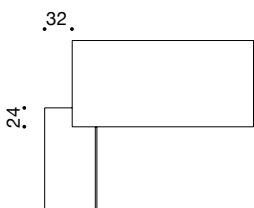
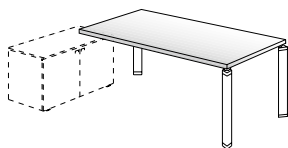

DESCRIZIONE

Scrivanie con gambe predisposta per servente portante (può essere montata destra o sinistra) (ordinare servente pag. 37)
 Desk with legs predisposed for bearing pedestal (it can be fixed to the right or to the left) (order pedestal page 37)
 Bureau avec pieds équipé pour desserte porteuse (peut être monté à droite ou à gauche) (commander desserte page 37)
 Escritorio con patas preparado para pedestal portante (puede montarse a la derecha o a la izquierda) (pedir pedestal página 37)

MISURA	CODICE	Piano impiallacciato Veneered worktop / Plateau plaqué / Superficie enchapada			
180x100	17803	WE wengé wengé wengé wengé			
210x100	17804		1.823,00		
			1.958,00		

MUST

ELEMENTO

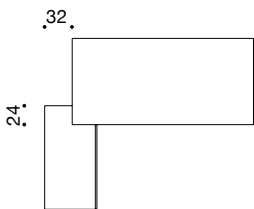
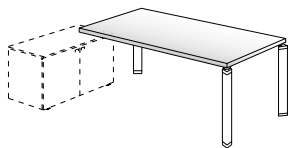

DESCRIZIONE

Scrivanie con gambe predisposta per servente portante (può essere montata destra o sinistra) (ordinare servente pag. 37)
 Desk with legs predisposed for bearing pedestal (it can be fixed to the right or to the left) (order pedestal page 37)
 Bureau avec pieds équipé pour desserte porteuse (peut être monté à droite ou à gauche) (commander desserte page 37)
 Escritorio con patas preparado para pedestal portante (puede montarse a la derecha o a la izquierda) (pedir pedestal página 37)

MISURA	CODICE	Piano vetro Glass worktop / Plateau en verre / Superficie de cristal			
180x100	17803	S satinato satinéd satiné satinado	KV nero black noir negro	VV curry (ral 1027) curry curry curry	
210x100	17804		1.658,00	1.773,00	1.773,00
			1.759,00	1.893,00	1.893,00

H75

Scrivanie serie "trapezio" "Trapezoidal" series desks Bureaux série "trapézoïdale" Escritorios serie "trapezoidal"

ELEMENTO



DESCRIZIONE

Scrivania con gambe

Desk with legs
Bureau avec pieds
Escritorio con patas

		Piano vetro Glass worktop / Plateau en verre / Superficie de cristal			
MISURA	CODICE	S satinato satinéd satiné satinado	KV nero black noir negro	VV curry (ral 1027) curry curry curry	
210x111	17810	2.185,00	2.357,00	2.357,00	

ELEMENTO

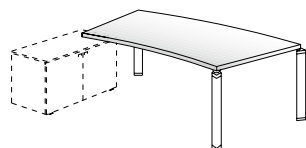

DESCRIZIONE

Scrivania con gambe predisposta per servente portante (può essere montata destra o sinistra) (ordinare servente pag. 37)

Desk with legs predisposed for bearing pedestal
(it can be fixed to the right or to the left) (order pedestal page 37)
Bureau avec pieds équipé pour desserte porteuse
(peut être monté à droite ou à gauche) (commander desserte page 37)
Escritorio con patas preparado para pedestal portante
(puede montarse a la derecha o a la izquierda) (pedir pedestal página 37)

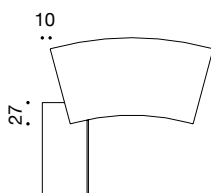

		Piano vetro Glass worktop / Plateau en verre / Superficie de cristal			
MISURA	CODICE	S satinato satinéd satiné satinado	KV nero black noir negro	VV curry (ral 1027) curry curry curry	
210x111	17812	2.094,00	2.263,00	2.263,00	

ELEMENTO

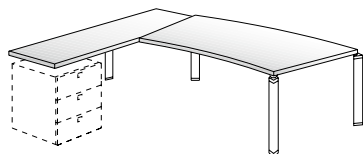

DESCRIZIONE

Scrivania con gambe e complanare
(il disegno si riferisce alla scrivania sx) (ordinare cassettera pag. 36)

Desk with legs and return top
 (sx illustrated) (order drawer unit page 36)

Bureau avec pieds et retour
 (le dessin se réfère au bureau sx) (commander caisson page 36)

Escritorio con patas y extensión
 (el dibujo se refiere al escritorio sx) (pedir cajonera página 36)

		Piano vetro Glass worktop / Plateau en verre / Superficie de cristal			
		S satinato satinéd satiné satinado	KV nero black noir negro	VV curry (ral 1027) curry curry curry	
MISURA	CODICE				
243x224	DX 17814 SX 17815	3.299,00	3.566,00	3.566,00	

MUST

H75

Scrivanie serie "ovale"
 "Oval" series desks
 Bureaux série "ovale"
 Escritorios serie "ovalada"

ELEMENTO



DESCRIZIONE

Scrivania con gambe

Desk with legs
 Bureau avec pieds
 Escritorio con patas

		Piano vetro Glass worktop / Plateau en verre / Superficie de cristal			
MISURA	CODICE	S satinato satinéd satiné satinado	KV nero black noir negro	VV curry (ral 1027) curry curry curry	
240x118	17820	2.556,00	2.789,00	2.789,00	

ELEMENTO

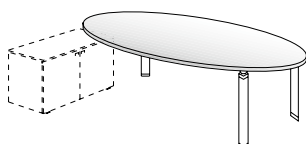

DESCRIZIONE

**Scrivania con gambe predisposta per servente portante
 (può essere montata destra o sinistra) (ordinare servente pag. 37)**

Desk with legs predisposed for bearing pedestal
 (it can be fixed to the right or to the left) (order pedestal page 37)
 Bureau avec pieds équipé pour desserte porteuse
 (peut être monté à droite ou à gauche) (commander desserte page 37)
 Escritorio con patas preparado para pedestal portante
 (puede montarse a la derecha o a la izquierda) (pedir pedestal página 37)

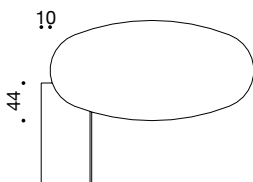

		Piano vetro Glass worktop / Plateau en verre / Superficie de cristal			
MISURA	CODICE	S satinato satinéd satiné satinado	KV nero black noir negro	VV curry (ral 1027) curry curry curry	
240x118	17822	2.461,00	2.689,00	2.689,00	

ELEMENTO



DESCRIZIONE

Scrivania con gambe
 Desk with legs
 Bureau avec pieds
 Escritorio con patas

		Piano vetro Glass worktop / Plateau en verre / Superficie de cristal			
		S satinato satinéd satiné satinado	KV nero black noir negro	VV curry (ral 1027) curry curry curry	
MISURA	CODICE				
150x150	17830	2.001,00	2.155,00	2.155,00	

MUST

ELEMENTO

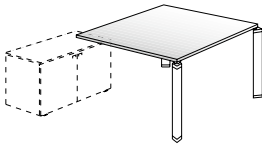

DESCRIZIONE

**Scrivania con gambe predisposta per servente portante
 (può essere montata destra o sinistra) (ordinare servente pag. 37)**
 Desk with legs predisposed for bearing pedestal
 (it can be fixed to the right or to the left) (order pedestal page 37)
 Bureau avec pieds équipé pour desserte porteuse
 (peut être monté à droite ou à gauche) (commander desserte page 37)
 Escritorio con patas preparado para pedestal portante
 (puede montarse a la derecha o a la izquierda) (pedir pedestal página 37)

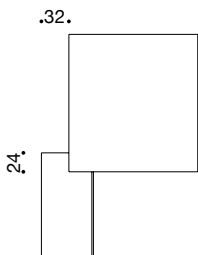

		Piano vetro Glass worktop / Plateau en verre / Superficie de cristal			
		S satinato satinéd satiné satinado	KV nero black noir negro	VV curry (ral 1027) curry curry curry	
MISURA	CODICE				
150x150	17832	1.908,00	2.065,00	2.065,00	

ELEMENTO

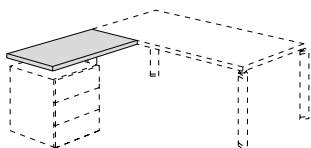

DESCRIZIONE

Complanare rettangolare per scrivania con piano impiallacciato (può essere montato destro o sinistro) (ordinare cassetiera pag. 36)
 Rectangular return top for desk with veneered worktop (it can be fixed to the right or to the left) (order drawer unit page 36)
 Retour rectangulaire pour bureau avec plateau plaqué (peut être monté à droite ou à gauche) (commander caisson page 36)
 Extensión rectangular para escritorio con superficie enchapada (puede montarse a la derecha o a la izquierda) (pedir cajonera página 36)

		Piano impiallacciato Veneered worktop / Plateau plaque / Superficie enchapada			
		WE wengé wengé wengé wengé			
MISURA	CODICE				
120x60	17835	569,00			

ELEMENTO



DESCRIZIONE

Complanare semicerchio (può essere montato destro o sinistro)
 Semicircular extension (it can be fixed to the right or to the left)
 Retour semi-circulaire (peut être monté à droite ou à gauche)
 Extensión lateral semicircular (puede montarse a la derecha o a la izquierda)

		Piano impiallacciato Veneered worktop / Plateau plaque / Superficie enchapada			
		S satinato satinéd satiné satinado	KV nero black noir negro	VV curry (ral 1027) curry curry curry	
MISURA	CODICE				
100x80	17840	1.190,00	1.244,00	1.244,00	

ELEMENTO



DESCRIZIONE

Complanare semicerchio

Semicircular extension
Retour semi-circulaire
Extensión lateral semicircular

		Piano vetro Glass worktop / Plateau en verre / Superficie de cristal			
		S satinato satinéd satiné satinado	KV nero black noir negro	VV curry (ral 1027) curry curry curry	
MISURA	CODICE				
100x80	17850	1.305,00	1.362,00	1.362,00	

MUST

ELEMENTO



DESCRIZIONE

**Complanare rotondo (non applicabile in composizione con piani ovali)
(può essere montato destro o sinistro)**

Round extension (not applicable in compositions with oval tops)
(it can be fixed to the right or to the left)
Retour rond (ne pas applicable dans les compositions avec plateaux ovales)
(peut être monté à droite ou à gauche)
Extensión lateral redonda (no aplicable a composiciones con superficies ovaladas)
(puede montarse a la derecha o a la izquierda)

		Piano vetro Glass worktop / Plateau en verre / Superficie de cristal			
		S satinato satinéd satiné satinado	KV nero black noir negro	VV curry (ral 1027) curry curry curry	
MISURA	CODICE				
Ø 120	17841	1.613,00	1.710,00	1.710,00	

ELEMENTO

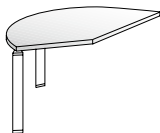

DESCRIZIONE

**Complanare per scrivania serie trapezio
(può essere montato destro o sinistro)**

Extension for "trapezoidal" series desk
(it can be fixed to the right or to the left)
Retour pour bureau serie "trapézoïdale"
(peut être monté à droite ou à gauche)
Extensión lateral para escritorio serie "trapezoidal"
(puede montarse a la derecha o a la izquierda)

		Piano vetro Glass worktop / Plateau en verre / Superficie de cristal			
		S satinato satinéd satiné satinado	KV nero black noir negro	VV curry (ral 1027) curry curry curry	
MISURA	CODICE				
104x203	17843	1.727,00	1.878,00	1.878,00	

Modesty panels
 Modesty panels
 Voiles de fond
 Faldones

ELEMENTO

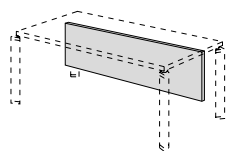

DESCRIZIONE

Modesty panel Sp 1.8 per scrivanie serie "rettangolare"

1.8 thick modesty panel for "rectangular" series desks
 Voile de fond épaisseur 1,8 pour bureaux série "rectangulaire"
 Faldón de 1,8 de grosor para escritorios serie "rectangular"

		Piano impiallacciato Veneered worktop / Plateau plaqué Superficie enchapada		Laccato Lacquered / Laque / Lacado	
		WE wengé wengé wengé wengé		WO bianco opaco matt white blanc opaque blanco mate	
MISURA	CODICE				
176x35	17860		375,00		332,00
198x35	17861		415,00		369,00

ELEMENTO

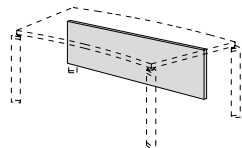

DESCRIZIONE

Modesty panel Sp 1.8 per scrivanie serie "trapezio"

1.8 thick modesty panel for "trapezoidal" series desks
 Voile de fond épaisseur 1,8 pour bureaux série "trapezoidale"
 Faldón de 1,8 de grosor para escritorios serie "trapezoidal"

		Piano impiallacciato Veneered worktop / Plateau plaqué Superficie enchapada		Laccato Lacquered / Laque / Lacado	
		WE wengé wengé wengé wengé		WO bianco opaco matt white blanc opaque blanco mate	
MISURA	CODICE				
198x35	17862		415,00		369,00

ELEMENTO

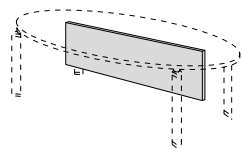

DESCRIZIONE

Modesty panel Sp 1.8 per scrivanie serie "ovale"

1.8 thick modesty panel for "oval" series desks
 Voile de fond épaisseur 1,8 pour bureaux serie "ovale"
 Faldón de 1,8 de grosor para escritorios serie "ovalada"

		Piano impiallacciato Veneered worktop / Plateau plaqué Superficie enchapada		Laccato Lacquered / Laque / Lacado	
		WE wengé wengé wengé wengé		WO bianco opaco matt white blanc opaque blanco mate	
MISURA	CODICE				
198x35	17863		415,00		369,00

MUST

Eplicativo componibilità tavoli riunione
Meeting table composition details
Details de composition pour tables réunion
Explicativo de composición para mesas de reuniones

ELEMENTO

Per comporre tavoli riunione con misure diverse da quelli presenti nelle pagine seguenti del listino, aggiungere gli allunghi di pag. 28

In order to compose meeting tables with measurements other than the ones present in the following pages of the price list, add the extensions as shown on page 28
Pour composer des tables réunion ayant des mesures différentes de celles figurant dans les pages suivantes de la liste, ajouter les rallonges de page 28
Para componer mesas de reuniones con medidas distintas de las que aparecen en las páginas siguientes de la lista, añadan las extensiones de la página 28

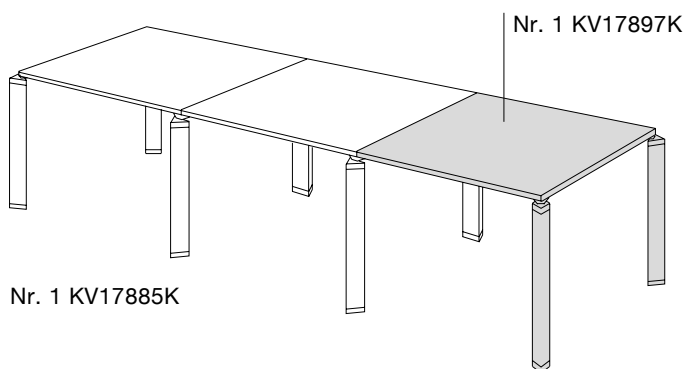
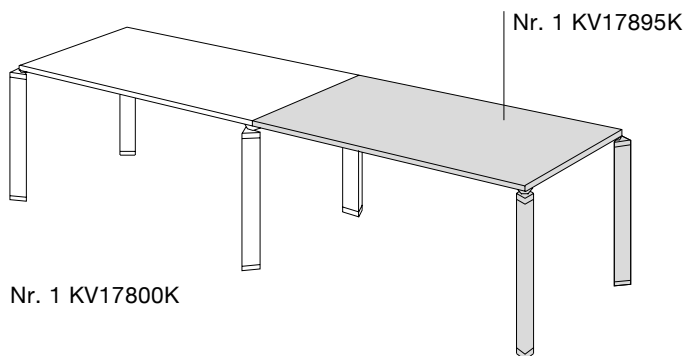

ELEMENTO



DESCRIZIONE

Tavolo riunione rettangolare

Rectangular meeting table
Table réunion rectangulaire
Mesa de reuniones rectangular

		Piano impiallacciato Veneered worktop / Plateau plaqué Superficie enchapada			
		WE wengé wengé wengé wengé			
MISURA	CODICE				
180x100	17800	1.914,00			
210x100	17801	2.048,00			

		Piano vetro Glass worktop / Plateau en verre / Superficie de cristal			
		S satinato satiné satiné satinado	KV nero black noir negro	VV curry (ral 1027) curry curry curry	
MISURA	CODICE				
180x100	17800	1.748,00	1.863,00	1.863,00	
210x100	17801	1.849,00	1.984,00	1.984,00	

ELEMENTO



DESCRIZIONE

Tavolo riunione quadrato

Square meeting table
Table réunion carrée
Mesa de reuniones cuadrada

		Piano vetro Glass worktop / Plateau en verre / Superficie de cristal			
		S satinato satiné satiné satinado	KV nero black noir negro	VV curry (ral 1027) curry curry curry	
MISURA	CODICE				
118x118	17870	1.754,00	1.850,00	1.850,00	
150x150	17830	2.001,00	2.155,00	2.155,00	

ELEMENTO



DESCRIZIONE

Tavolo riunione rotondo

Round meeting table
Table réunion ronde
Mesa de reuniones redonda

		Piano vetro Glass worktop / Plateau en verre / Superficie de cristal			
MISURA	CODICE	S satinato satinéd satiné satinado	KV nero black noir negro	VV curry (ral 1027) curry curry curry	
Ø 118	17872	1.724,00	1.827,00	1.827,00	

ELEMENTO



DESCRIZIONE

Tavolo riunione ovale

Oval meeting table
Table réunion ovale
Mesa de reuniones ovalada

		Piano vetro Glass worktop / Plateau en verre / Superficie de cristal			
MISURA	CODICE	S satinato satinéd satiné satinado	KV nero black noir negro	VV curry (ral 1027) curry curry curry	
240x118	17820	2.556,00	2.789,00	2.789,00	

ELEMENTO

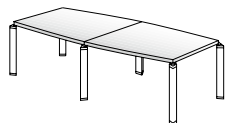

DESCRIZIONE

Tavolo riunione sagomato
Shaped meeting table
Table réunion façonnée
Mesa de reuniones perfilada

MISURA		DESCRIZIONE			
CODICE		Piano vetro Glass worktop / Plateau en verre / Superficie de cristal			
		S satinato satinéd satiné satinado	KV nero black noir negro	VV curry (rat 1027) curry curry curry	
300x118	17875	3.324,00	3.586,00	3.586,00	

MUST

ELEMENTO

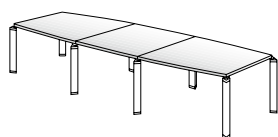

DESCRIZIONE

Tavolo riunione sagomato
Shaped meeting table
Table réunion façonnée
Mesa de reuniones perfilada

MISURA		DESCRIZIONE			
CODICE		Piano vetro Glass worktop / Plateau en verre / Superficie de cristal			
		S satinato satinéd satiné satinado	KV nero black noir negro	VV curry (rat 1027) curry curry curry	
418x118	17876	4.297,00	4.658,00	4.658,00	

ELEMENTO



DESCRIZIONE

Tavolo riunione rettangolare

Rectangular meeting table

Table réunion rectangulaire

Mesa de reuniones rectangular

MISURA		CODICE	Piano vetro Glass worktop / Plateau en verre / Superficie de cristal		
			S satinato satinéd satiné satinado	KV nero black noir negro	VV curry (ral 1027) curry curry curry
236x118	17885		3.121,00	3.312,00	3.312,00
300x150	17886		3.625,00	3.935,00	3.935,00

ELEMENTO



DESCRIZIONE

Tavolo riunione rettangolare

Rectangular meeting table

Table réunion rectangulaire

Mesa de reuniones rectangular

MISURA		CODICE	Piano impiallacciato Veneered worktop / Plateau plaqué Superficie enchapada		
			WE wengé wengé wengé wengé		
180x200	17880		3.470,00		
210x200	17881		3.742,00		

MISURA		CODICE	Piano vetro Glass worktop / Plateau en verre / Superficie de cristal		
			S satinato satinéd satiné satinado	KV nero black noir negro	VV curry (ral 1027) curry curry curry
180x200	17880		3.121,00	3.350,00	3.350,00
210x200	17881		3.324,00	3.591,00	3.591,00

ELEMENTO



DESCRIZIONE

Tavolo riunione ovale
Oval meeting table
Table réunion ovale
Mesa de reuniones ovalada

MISURA		CODICE		DESCRIZIONE	
366x232		17890		Piano vetro Glass worktop / Plateau en verre / Superficie de cristal	
				S satinato satinéd satiné satinado	KV nero black noir negro
				VV curry (ral 1027) curry curry curry	
		7.435,00	8.077,00	8.077,00	

ELEMENTO

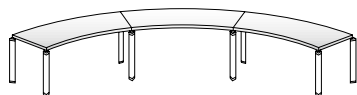

DESCRIZIONE

Tavolo riunione ad "arco"
"Arch" shaped meeting table
Table réunion en "arc"
Mesa de reuniones de "arco"

MISURA		CODICE		DESCRIZIONE	
581x194		17892		Piano vetro Glass worktop / Plateau en verre / Superficie de cristal	
				S satinato satinéd satiné satinado	KV nero black noir negro
				VV curry (ral 1027) curry curry curry	
		5.783,00	6.288,00	6.288,00	

ELEMENTO

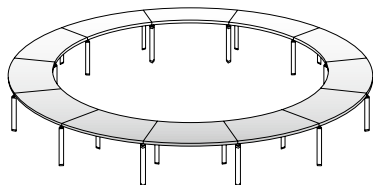

DESCRIZIONE

Tavolo riunione rotondo
Round meeting table
Table réunion ronde
Mesa de reuniones redonda

MISURA		CODICE		DESCRIZIONE	
Ø 820		17894		Piano vetro Glass worktop / Plateau en verre / Superficie de cristal	
				S satinato satinéd satiné satinado	KV nero black noir negro
				VV curry (ral 1027) curry curry curry	
		21.786,00	23.594,00	23.594,00	

ELEMENTO



DESCRIZIONE

Allungo rettangolare
Rectangular extension
Rallonge rectangulaire
Extensión rectangular

MISURA		CODICE	DESCRIZIONE		
			Piano impiallacciato Veneered worktop / Plateau plaqué Superficie enchapada		
			WE wengé wengé wengé wengé		
180x100		17895	1.548,00		
210x100		17896	1.685,00		

MISURA		CODICE	DESCRIZIONE		
			Piano vetro Glass worktop / Plateau en verre / Superficie de cristal		
			S satinato satinéd satiné satinado	KV nero black noir negro	VV curry (ral 1027) curry curry curry
180x100		17895	1.373,00	1.489,00	1.498,00
210x100		17896	1.476,00	1.609,00	1.609,00

ELEMENTO



DESCRIZIONE

Allungo quadrato
Square extension
Rallonge carrée
Extensión cuadrada

MISURA		CODICE	DESCRIZIONE		
			Piano vetro Glass worktop / Plateau en verre / Superficie de cristal		
			S satinato satinéd satiné satinado	KV nero black noir negro	VV curry (ral 1027) curry curry curry
118x118		17897	1.366,00	1.462,00	1.462,00
150x150		17898	1.625,00	1.780,00	1.780,00

ELEMENTO

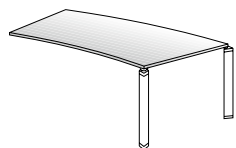

DESCRIZIONE

Allungo trapezio
 Trapezoidal extension
 Rallonge trapézoïdale
 Extensión trapezoidal

MISURA		CODICE		DESCRIZIONE	
210x111		17899		Piano vetro Glass worktop / Plateau en verre / Superficie de cristal	
		S satinato satinéd satiné satinado	KV nero black noir negro	VV curry (ral 1027) curry curry curry	
		1.798,00	1.967,00	1.967,00	

MUST

H40

Zona di attesa
 Waiting area
 Zone d'accueil
 Zona de espera

ELEMENTO

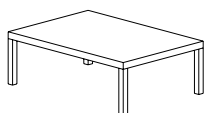

DESCRIZIONE

Tavolo rettangolare con gambe cromate
 Rectangular table with chrome-plated legs
 Table rectangulaire avec pieds chromés
 Mesa rectangular con patas cromadas

		Piano impiallacciato Veneered worktop / Plateau plaqué Superficie enchapada		Laccato Laquered / Laqué / Lacado	
		WE wengé wengé wengé wengé		WO bianco opaco matt white blanc opaque blanco mate	
MISURA	CODICE				
120x60	19630	815,00		815,00	

ELEMENTO

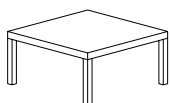

DESCRIZIONE

Tavolo quadrato con gambe cromate
 Square table with chrome-plated legs
 Table carree avec pieds chromés
 Mesa cuadrada con patas cromadas

		Piano impiallacciato Veneered worktop / Plateau plaqué Superficie enchapada		Laccato Laquered / Laqué / Lacado	
		WE wengé wengé wengé wengé		WO bianco opaco matt white blanc opaque blanco mate	
MISURA	CODICE				
60x60	19635	641,00		641,00	

Il sistema di boiserie prevede, in larghezza, due tipologie: modulo singolo cm 105 (solo con mensole) e modulo doppio cm 210 (con possibilità di montare sia solo mensole che mensole più mobili pensili). Nella versione modulo singolo è necessario affiancare due contenitori H cm 160, completi di top ed eventuali fianchi di finitura. In entrambi i casi il pannello boiserie deve essere fissato al muro retrostante

The boiserie system includes two different widths: a 105cm single module (with shelves only) or a 210 cm double module (with the possibility of fixing shelves only as well as wall units). In the single module version, two 160cm high storage units must be used complete with tops and optional finishing side panels. In both cases the boiserie panel must be fixed to the wall at the back

Le système de boiserie prévoit, pour la largeur, deux typologies: un module individuel de 105 cm (uniquement avec étagères) et un module double de 210 cm (avec la possibilité de monter soit uniquement des étagères soit des étagères ainsi que des éléments hauts). Dans la version module individuel, il est nécessaire de placer sur les côtés deux armoires H 160 cm, équipées de tops et d'éventuelles joues de finition. Dans les deux cas, le panneau de boiserie doit être fixé au mur situé à l'arrière

El sistema de boiserie prevé, en anchura, dos tipos: módulo individual de 105 cm. (sólo con estantes) y módulo doble de 210 cm. (con posibilidad de montar ya sea sólo estantes que estantes más módulos altos). En la versión módulo individual hay que colocar al lado dos armarios H 160 cm. con tops y eventuales laterales. En ambos casos, el panel de la boiserie tiene que estar sujeto a la pared de atrás

ESEMPI DI CONFIGURAZIONE
CONFIGURATION EXAMPLES
EXEMPLES DE DISPOSITION
EJEMPLOS

Modulo cm 105
105 cm module
Module 105 cm
Módulo 105 cm

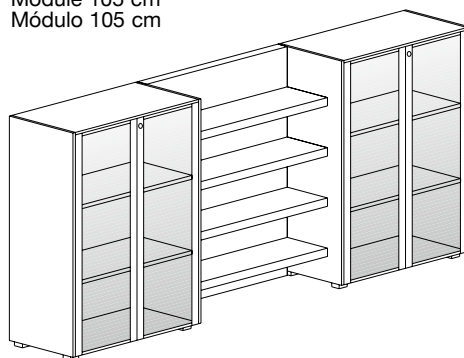

Modulo cm 210
210 cm module
Module 210 cm
Módulo 210 cm

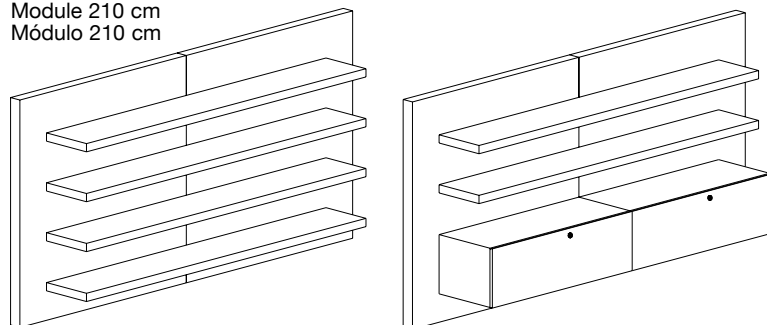

ELEMENTO

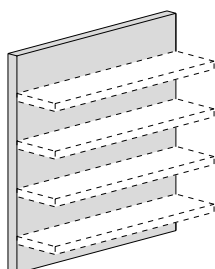

DESCRIZIONE

Modulo singolo boiserie H 164.5 predisposto per l'aggancio di 4 mensole completo di ferramenta per fissaggio a muro

H 164.5 single boiserie module predisposed for fixing of 4 shelves with hardware for wall fixing

Module individuel boiserie H 164,5 equipe pour fixer 4 etageres avec ferrure pour fixage au mur

módulo boiserie individual H 164,5 preparado para enganchar 4 estantes con ferreria para sujetarlo a la pared

		Piano impiallacciato Veneered worktop / Plateau plaqué Superficie enchapada		Laccato Lacquered / Laqué / Lacado	
		WE wengé wengé wengé wengé		WO bianco opaco matt white blanc opaque blanco mate	
MISURA	CODICE				
105x6	17900	1.010,00		936,00	

ELEMENTO

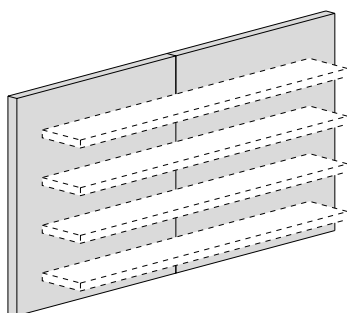

DESCRIZIONE

Modulo doppio boiserie H 164.5 predisposto per l'aggancio di 4 mensole oppure 2 mensole più due mobili pensili

Completo di ferramenta per fissaggio a muro H 164.5 double boiserie module predisposed for fixing of 4 shelves or shelves plus 2 wall units with hardware for wall fixing

Module double boiserie H 164.5 équipé pour fixer 4 étagères ou 2 étagères plus deux éléments hauts avec ferrure pour fixage au mur

Módulo boiserie doble H 164,5 preparado para enganchar 4 estantes o 2 estantes más 2 módulos altos con ferreria para sujetarlo a la pared

		Piano impiallacciato Veneered worktop / Plateau plaqué Superficie enchapada		Laccato Lacquered / Laqué / Lacado	
		WE wengé wengé wengé wengé		WO bianco opaco matt white blanc opaque blanco mate	
MISURA	CODICE				
210x6	17901	2.019,00		1.872,00	

ELEMENTO

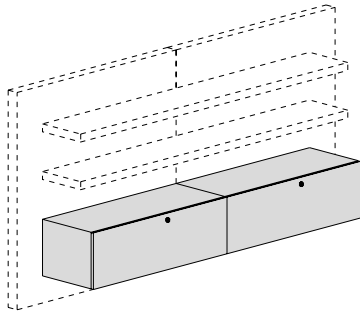

DESCRIZIONE

**Coppia contenitori pensili H 43 con anta a ribalta
(viene fornito già assemblato) (occupa lo spazio di 2 mensole)**

Pair of H 43 wall units with dropleaf opening
(it is supplied already assembled) (it occupies the space of 2 shelves)
Paire d'éléments hauts H 43 avec porte basculante
(est fourni déjà assemblé) (occupe la place de 2 étagères)
Par de módulos altos H 43 con puerta abatible
(se entrega montado) (ocupa el espacio de 2 estantes)

		Piano impiallacciato Veneered worktop / Plateau plaqué Superficie enchapada		Laccato Lacquered / Laqué / Lacado	
		WE wengé wengé wengé wengé		WO bianco opaco matt white blanc opaque blanco mate	
MISURA	CODICE				
178x42	17907	2.667,00		2.291,00	

MUST

ELEMENTO

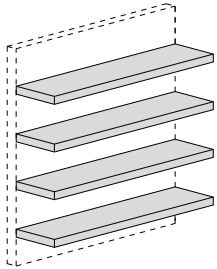

DESCRIZIONE

**Mensole per modulo singolo
(portata massima 40 kg uniformemente distribuiti)**

Shelves for single module
(max 40 kg evenly distributed)
Étagères pour module individuel
(portée 40 kg uniformément répartis)
Estantes para módulo individual
(soportan hasta 40 kg uniformemente distribuidos)

		Piano impiallacciato Veneered worktop / Plateau plaqué Superficie enchapada		Laccato Lacquered / Laqué / Lacado	
		WE wengé wengé wengé wengé		WO bianco opaco matt white blanc opaque blanco mate	
MISURA	CODICE				
N. 4 105x27	17903	1.595,00		1.420,00	

		Piano vetro Glass worktop / Plateau en verre / Superficie de cristal			
		S satinato satinéd satiné satinado	KV nero black noir negro	VV curry (ral 1027) curry curry curry	
MISURA	CODICE				
N. 4 105x27	17903	1.101,00	1.172,00	1.172,00	

ELEMENTO

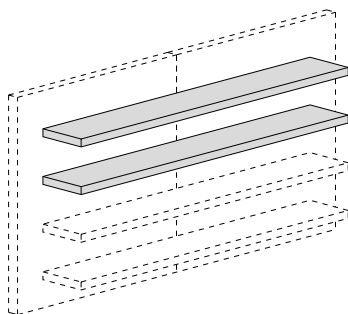

DESCRIZIONE

Mensola per modulo doppio (portata massima 40 kg uniformemente distribuiti)

Shelves for double module
(max 40 kg evenly distributed)
Étagères pour module double
(portée 40 kg uniformément répartis)
Estantes para módulo doble
(soportan hasta 40 kg uniformemente distribuidos)

		Piano impiallacciato Veneered worktop / Plateau plaqué Superficie enchapada		Laccato Lacquered / Laqué / Lacado	
		WE wengé wengé wengé wengé		WO bianco opaco matt white blanc opaque blanco mate	
	MISURA	CODICE			
N. 2	105x27	17904	1.270,00		1.132,00
N. 4	105x27	17905	2.540,00		2.261,00

		Vetro Glass / Verre / Cristal			
		S satinato satinéd satiné satinado	KV nero black noir negro	VV curry (ral 1027) curry curry curry	
	MISURA	CODICE			
N. 2	178x27	17904	846,00	907,00	907,00
N. 4	178x27	17905	1.691,00	1.813,00	1.813,00

Cassettiere e serventi
 Drawer units and pedestals
 Caissons et dessertes
 Cajoneras y pedestales

ELEMENTO

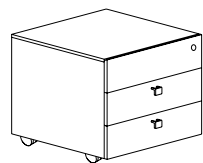

DESCRIZIONE

**Cassettiera H64 / P60 su ruote con 3 cassetti legno
 (viene fornita già assemblata)**

H64 / D60 3 wooden drawer unit on castors
 (supplied already assembled)
 Caisson a 3 tiroirs en bois H64 / P60 sur roulettes
 (est fourni déjà assemblé)
 Cajonera con 3 cajones de madera H64 / P60 con ruedas
 (se entrega montada)

		Piano impiallacciato Veneered worktop / Plateau plaqué Superficie enchapada		Laccato Lacquered / Laqué / Lacado	
		WE wengé wengé wengé wengé		WO bianco opaco matt white blanc opaque blanco mate	
MISURA	CODICE				
60	17908	1.503,00		1.422,00	

MUST

ELEMENTO

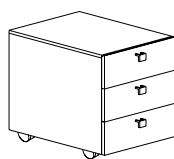

DESCRIZIONE

**Cassettiera H61 / P56 su ruote con 3 cassetti metallo
 (viene fornita già assemblata)**

H61 / D56 3 metal drawer unit on castors
 (supplied already assembled)
 Caisson a 3 tiroirs en metal H61 / P56 sur roulettes
 (est fourni déjà assemblé)
 Cajonera con 3 cajones de metal H61 / P56 con ruedas
 (se entrega montada)

		Piano impiallacciato Veneered worktop / Plateau plaqué Superficie enchapada		Laccato Lacquered / Laqué / Lacado	
		WE wengé wengé wengé wengé		WO bianco opaco matt white blanc opaque blanco mate	
MISURA	CODICE				
42	17909	830,00		830,00	

Cassettiere e serventi
 Drawer units and pedestals
 Caissons et dessertes
 Cajoneras y pedestales

ELEMENTO

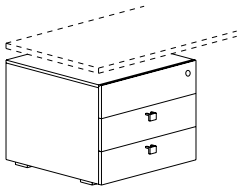

DESCRIZIONE

**Cassettiera portante H64 / P60 con 3 cassetti legno
 (viene fornita già assemblata)**

H64 / D60 3 wooden bearing drawer unit on castors
 (supplied already assembled)
 Caisson porteur a 3 tiroirs en bois H64 / P60 sur roulettes
 (est fourni déjà assemblé)
 Cajonera portante con 3 cajones de madera H64 / P60 con ruedas
 (se entrega montada)

		Piano impiallacciato Veneered worktop / Plateau plaqué Superficie enchapada		Laccato Lacquered / Laqué / Lacado	
		WE wengé wengé wengé wengé		WO bianco opaco matt white blanc opaque blanco mate	
MISURA	CODICE				
60	17910		1.541,00		1.461,00

ELEMENTO

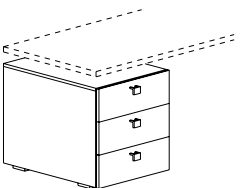

DESCRIZIONE

**Cassettiera H61 / P56 su ruote con 3 cassetti metallo
 (viene fornita già assemblata)**

H61 / D56 3 metal drawer unit on castors
 (supplied already assembled)
 Caisson a 3 tiroirs en metal H61 / P56 sur roulettes
 (est fourni déjà assemblé)
 Cajonera con 3 cajones de metal H61 / P56 con ruedas
 (se entrega montada)

		Piano impiallacciato Veneered worktop / Plateau plaqué Superficie enchapada		Laccato Lacquered / Laqué / Lacado	
		WE wengé wengé wengé wengé		WO bianco opaco matt white blanc opaque blanco mate	
MISURA	CODICE				
42	17911		936,00		936,00

Cassettiere e serventi
 Drawer units and pedestals
 Caissons et dessertes
 Cajoneras y pedestales

ELEMENTO

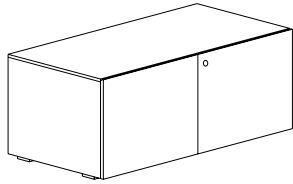

DESCRIZIONE

Servente H64 / P60 con 2 ante
(viene fornito già assemblato) 1 ripiano - serratura
 H64 / D60 pedestal with 2 doors
 (it is supplied already assembled) 1 shelf - lock
 Desserte H64 / P60 avec 2 portes
 (est fournie déjà assemblée) 1 tablette - serrure
 Pedestal H64 / P60 con 2 puertas
 (se entrega montado) 1 estante - cerradura

MISURA	CODICE	Piano impiallacciato Veneered worktop / Plateau plaqué Superficie enchapada		Laccato Lacquered / Laqué / Lacado	
		WE wengé wengé wengé wengé		WO bianco opaco matt white blanc opaque blanco mate	
120	17914	2.255,00		1.872,00	

MUST

ELEMENTO

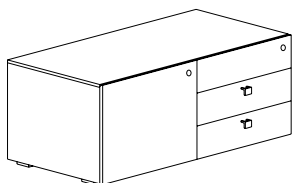

DESCRIZIONE

Servente H64 / P60 con anta e 3 cassetti (viene fornito già assemblato)
1 ripiano - serratura (il disegno si riferisce al servente sx)
 H64 / D60 pedestal with door and 3 drawer unit (it is supplied already assembled)
 1 shelf - lock (sx illustrated)
 Desserte H64 / P60 avec porte et 3 tiroirs (est fournie déjà assemblée)
 1 tablette - serrure (le dessin se réfère au desserte sx)
 Pedestal H64 / P60 con puerta y 3 cajones (se entrega montado)
 1 estante - cerradura (el dibujo se refiere al pedestal sx)

MISURA	CODICE	Piano impiallacciato Veneered worktop / Plateau plaqué Superficie enchapada		Laccato Lacquered / Laque / Lacado	
		WE wengé wengé wengé wengé		WO bianco opaco matt white blanc opaque blanco mate	
120	DX 17915 SX 17916	2.639,00		2.290,00	

Cassettiere e serventi
 Drawer units and pedestals
 Caissons et dessertes
 Cajoneras y pedestales

ELEMENTO

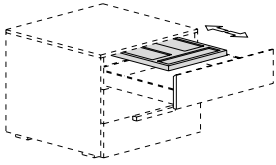

DESCRIZIONE

**Cassetto porta cancelleria (da montare sotto il top)
 inseribile nei codici: 17908 - 17910 - 17915 - 17916**

Stationary tray (to be mounted below the top)
 it can be inserted into the codes: 17908 - 17910 - 17915 - 17916
 Tirette porte-plumier (à installer dessous le top)
 insérable dans les codes: 17908 - 17910 - 17915 - 17916
 Cajón plumier (que se coloca debajo de la encimera)
 colocable en los códigos: 17908 - 17910 - 17915 - 17916

		Plastica Plastic / Plastique / Plástico			
		C accessori accessories accessoires accesorios			
MISURA	CODICE				
	19675	30,00			

ELEMENTO

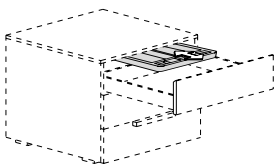

DESCRIZIONE

**Cassetto H5 porta cancelleria
 inseribile nei codici: 17909 - 17911**

H5 stationary tray
 it can be inserted into the codes: 17909 - 17911
 Tirette porte-plumier H5
 insérable dans les codes: 17909 - 17911
 Cajón plumier H5
 colocable en los códigos: 17909 - 17911

		Plastica Plastic / Plastique / Plástico			
		C accessori accessories accessoires accesorios			
MISURA	CODICE				
38x50	13780	40,00			